

2.7GHz Spectrum Analyzer

Model: GSP-827

Operation Manual

EC Declaration of Conformity

We
GOOD WILL INSTRUMENT CO., LTD.
 No. 95-11, Pao-Chung Rd., Hsin-Tien City, Taipei Hsien, Taiwan
GOOD WILL INSTRUMENT (SUZHOU) CO., LTD.
 No. 69, Lushan Road, Suzhou New District Jiangsu, China
 declares that the below mentioned product

GSP-827

is herewith confirmed to comply with the requirements set out in the Council Directive on the Approximation of the Law of Member States relating to Electromagnetic Compatibility (89/336/EEC, 92/31/EEC, 93/68/EEC) and Low Voltage Equipment Directive (73/23/EEC, 93/68/EEC). For the evaluation regarding the Electromagnetic Compatibility and Low Voltage Equipment Directive, the following standards were applied:

⊙ EMC

| EN 61326-1: Electrical equipment for measurement, control and laboratory use — EMC requirements (1997+A1: 1998+A2: 2001) | |
|--|---|
| Conducted and Radiated Emissions EN 55011: 1998 class A | Electrostatic Discharge EN 61000-4-2: 1995+A1:1998 |
| Current Harmonic EN 61000-3-2: 2000 | Radiated Immunity EN 61000-4-3: 1996+A1:1998 |
| Voltage Fluctuation EN 61000-3-3: 1995 | Electrical Fast Transients EN 61000-4-4: 1995 |
| ----- | Surge Immunity EN 61000-4-5: 1995 |
| ----- | Conducted Susceptibility EN 61000-4-6: 1996 |
| ----- | Power Frequency Magnetic Field EN 61000-4-8 : 1993 |
| ----- | Voltage Dips/ Interrupts EN 61000-4-11: 1994 |

⊙ Safety

| Low Voltage Equipment Directive 73/23/EEC & amended by 93/68/EEC |
|--|
| Safety Requirements EN 61010-1: 2001 IEC 61010-1: 2001 |

| Table of Contents | Pages |
|---|--------------|
| 1.0 GENERAL DESCRIPTION AND FEATURES | 3 |
| 2.0 USAGE PRECAUTIONS AND RECOMMENDATIONS | 4 |
| 3.0 PRODUCT OPTION INFORMATION..... | 8 |
| 4.0 FIRST TIME USE..... | 9 |
| 4.1 INTERNAL CALIBRATION SIGNAL | 9 |
| 4.2 INSTALL AND UNINSTALL THE BATTERY | 10 |
| 5.0 PANEL DESCRIPTION | 11 |
| 5.1 FRONT PANEL DESCRIPTION | 11 |
| 5.2 REAR PANEL DESCRIPTIONS | 13 |
| 6.0 QUICK USE GUIDE | 15 |
| 6.1 GENERAL DESCRIPTION | 15 |
| 6.2 GUIDE | 15 |
| 6.2.1 FIND THE SIGNAL | 15 |
| 6.2.2 FIND PEAK SIGNAL..... | 15 |
| 6.2.3 TRACK PEAK SIGNAL | 16 |
| 6.2.4 MAKE CORRECT AMPLITUDE MEASUREMENT | 16 |
| 6.2.5 75Ω SYSTEM MEASUREMENT | 16 |
| 6.2.6 MULTI-MARKER OPERATION | 16 |
| 6.2.7 DELTA-MARKER OPERATION | 17 |
| 6.2.8 PEAK HOLD, AVERAGE AND FREEZE THE MEASUREMENT | 17 |
| 6.2.9 ACPR MEASUREMENT..... | 17 |
| 6.2.10 OCBW MEASUREMENT | 18 |
| 6.2.11 PASS/FAIL TEST BY LIMIT LINE..... | 18 |
| 6.2.12 EDIT THE LIMIT LINE, | 19 |
| 6.2.13 CHANGE RBW, VBW AND SWEEP TIME | 19 |
| 6.2.14 TRIGGER BY INPUT SIGNAL LEVEL..... | 19 |
| 6.2.15 TRIGGER BY EXTERNALLY STIMULUS SIGNAL | 20 |
| 6.2.16 OBSERVE TWO SWEEPS (EX, 2 ND HARMONIC) BY DUAL WINDOWS..... | 20 |
| 6.2.17 CONFIGURE DISPLAY SETTING | 20 |
| 6.2.18 SAVE MEASUREMENT/SETUP TO MEMORY | 21 |
| 6.2.19 RECALL TRACE/SETUP TO MEMORY | 21 |
| 6.2.20 TURN ON/OFF THE INTERNAL CALIBRATION SIGNAL..... | 21 |

| | |
|--|-----------|
| 6.2.21 CALENDAR/CLOCK SETTING | 21 |
| 6.2.22 PRESET SYSTEM | 22 |
| 6.2.23 SYSTEM INFORMATION..... | 22 |
| 6.2.24 SYNCHRONIZED BY EXTERNAL REFERENCE SIGNAL | 23 |
| 6.2.25 SYNCHRONIZE OTHER EQUIPMENTS..... | 23 |
| 6.2.26 TRACKING GENERATOR OPERATION (OPTION)..... | 23 |
| 7.0 MENU TREE..... | 24 |
| 7.1 MAIN FUNCTION | 24 |
| 7.2 MEASUREMENT FUNCTION | 25 |
| 7.3 CONTROL FUNCTION..... | 27 |
| 7.4 STATE FUNCTION | 28 |
| 8.0 OPERATION..... | 31 |
| 8.1 MAIN FUNCTIONS | 31 |
| 8.1.1 FREQUENCY FUNCTIONS | 31 |
| 8.1.2 SPAN FUNCTIONS..... | 36 |
| 8.1.3 AMPLITUDE..... | 39 |
| 8.2 MEASUREMENT FUNCTIONS..... | 43 |
| 8.2.1 MARKER | 43 |
| 8.2.2 PEAK SEARCH | 52 |
| 8.2.3 TRACE..... | 57 |
| 8.2.4 PWR MEASUREMENT..... | 61 |
| 8.2.5 LIMIT LINE..... | 68 |
| 8.3 CONTROL FUNCTIONS | 72 |
| 8.3.1 BW | 72 |
| 8.3.2 TRIGGER | 74 |
| 8.3.3 DISPLAY FUNCTIONS | 77 |
| 8.3.3 DISPLAY FUNCTIONS | 78 |
| 8.3.4 SAVE/RECALL..... | 80 |
| 8.4 STATE FUNCTIONS | 82 |
| 8.4.1 CALIBRATION | 82 |
| 8.4.2 SYSTEM..... | 83 |
| 8.4.3 OPTION | 87 |
| 8.4 POWER CONTROL..... | 92 |
| 8.5 DIAGNOSIS INFORMATION ON THE DISPLAY..... | 92 |
| 9.0 SPECIFICATION..... | 94 |

1.0 General Description and Features

The GSP-827 is designed with the features as follows.

- ✧ Synthesized-based design covering the frequency from 9kHz to 2.7GHz.
- ✧ Low noise design: -140dBm/Hz noise floor.
- ✧ 4.5kg light weight and compact size.
- ✧ 100 traces and setup memories.
- ✧ ACPR, OCBW, CHBW of power measurement.
- ✧ 11 ranges of external reference clock (64k~19.2M).
- ✧ 10 Markers with Peak, Peak Track, Δ Marker, Marker to Center functions.
- ✧ External and Video Level Trigger with single and continuous modes.
- ✧ Limit Line and Pass/Fail functions for quickly qualification test.
- ✧ Spilt Windows extend the measurement flexibility.
- ✧ Trace functions including Peak Hold, Average and Freeze.
- ✧ Optional Tracking Generator provides frequency response measurement in one sweep.
- ✧ Optional filters and Quasi- Peak detection provide EMI test.
- ✧ GPIB and RS232 interface for ATE applications.
- ✧ AC/DC dual modes power supply and Battery Operations.

The fully synthesized-based and low noise designs offer the high RF performance in measurement. The plentiful measurement functions like 10 markers, traces, power measurement, limit line, dual display and trigger make measurement more easily and quickly. The 100 memories, real time calendar and battery operation realize the true portability. 11 ranges of external reference clock offer the synchronization capability to many telecom standards. The optional Tracking Generator offers the frequency response test with the same frequency band. The GPIB and RS232 interfaces allow the connection between the unit and PC. Users can develop their own applications software. DC 12V power supply allows user to carry this unit to drive around for frequency monitoring. Chargeable battery pack can support the operation without power cord for 4 hours. With the carrying case, this unit is easy to carry and operate in the field service. 9k and 120k EMI filter and quasi-peak detector can perform the EMC test. AM/FM Demodulation provides the demodulated outputs through both headphone and speaker. Kit sets of connector adaptor offers the convenience under different measurement conditions.

This unit offers the right combination of highly RF performance, plentiful function, easily operated user interface and complete options to facilitate measurement in a wide range of application in laboratory as well as in field service usage. This is another example of our dedication to engineering excellence.

2.0 Usage Precautions and Recommendations

The following precautions are recommended to insure your safety and provide the best condition of GSP-827.

Safety Term and System

These terms may appear in this manual or on the product:



WARNING: Warning statements identify condition or practices that could result in injury or loss of life



CAUTION: Caution statements identify conditions or practices that could result in damage to this product or other property.

The following symbols may appear in this manual or on the product:



DANGER
High Voltage



ATTENTION
refer to
Manual



Protective
Conductor
Terminal



Earth (ground)
Terminal

FOR UNITED KINGDOM ONLY

NOTE: This lead / appliance must only be wired by competent persons



WARNING: THIS APPLIANCE MUST BE EARTHED

IMPORTANT: The wires in this lead are coloured in accordance with the following code:

| | |
|----------------|--------------|
| Green/ Yellow: | Earth |
| Blue: | Neutral |
| Brown: | Live (Phase) |

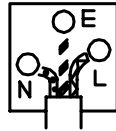

As the colours of the wires in main leads may not correspond with the colours marking identified in your plug/appliance, proceed as follows:

The wire which is coloured Green & Yellow must be connected to the Earth terminal marked with the letter E or by the earth symbol  or coloured Green or Green & Yellow.

The wire which is coloured Blue must be connected to the terminal which is marked with the letter N or coloured Blue or Black.

The wire which is coloured Brown must be connected to the terminal marked with the letter L or P or coloured Brown or Red.

If in doubt, consult the instructions provided with the equipment or contact the supplier.

This cable/appliance should be protected by a suitably rated and approved HBC mains fuse: refer to the rating information on the equipment and/or user instructions for details. As a guide, cable of 0.75mm^2 should be protected by a 3A or 5A fuse. Larger conductors would normally require 13A types, depending on the connection method used.

Any moulded mains connector that requires removal /replacement must be destroyed by removal of any fuse & fuse carrier and disposed of immediately, as a plug with bared wires is hazardous if a engaged in live socket. Any re-wiring must be carried out in accordance with the information detailed on this label.

Use and Wear



CAUTION

- Do not exceed +30 dBm into the RF INPUT or +30 dBm reverse power into the TG OUTPUT.
- Do not place any heavy object on the instrument.
- Avoid severe impacts or rough handling that could damage the GSP-827.
- Use electrostatic discharge precautions while handling and making connections to the GSP-827.
- Do not place wires into the connectors of the GSP-827, only mating connectors and adapters.
- Do not block or obstruct cooling fan vent opening on side panels or on the rear panel of unit.
- This equipment is not for measurements performed for CAT II, III, and IV.

1) Disassembly of the Instrument

- Do not disassemble the instrument; refer the instrument to a factory approved service facility only.

2) AC Power Input



CAUTION

- AC input should be within the range of selected line voltage $\pm 10\%$.
- Insure the correct fuse is installed prior to applying voltage for the first time:
90 V ~ 132 VAC input : T 1A / 250V
198 ~ 250 VAC input : T0.5A / 250V
- Check the line voltage setting on the rear panel. If the line voltage does not match input voltage, change as follows:
 - a) Remove AC Power Cord;
 - b) Open cover of AC socket with flat blade screwdriver;
 - c) Remove selector Cam Drum and rotate to the correct voltage selection
 - d) Replace Cam Drum.

3) Grounding



WARNING

- To avoid electrical shock, the power cord protective grounding conductor must be connected to earth ground.

4) Fuse Replacement



WARNING

- For continued fire protection, replace the fuse with the specified type and rating only.
- Disconnect power cord before replacing fuse.
- If the fuse is blown, there is something wrong with the instrument. Repair the cause of fault before replacing fuse.

5) Cleaning

- Disconnect AC Power Cord from the instrument before cleaning.
- Use a soft cloth dampened in a solution of mild detergent and water. Do not spray any liquid into the unit.
- Do not use chemicals or cleaners containing benzene, toluene, xylene, acetone or other harsh chemicals.

6) Operating Environment

- The following conditions are recommended for optimum use of the instrument:

| | | | |
|------------|--------------------|---------------------------|-------------------------|
| Indoor Use | Altitude < 2000 m | Temperature 18° to 28° C | Relative Humidity < 90% |
| Dust Free | No direct sunlight | No strong magnetic fields | |

- Installation Category: II
- Pollution degree: 2

7) Storage Environment

- The following conditions are recommended for optimum storage of the instrument -

| | | |
|--------|-------------------------|-------------------------|
| Indoor | Temperature 0° to 40° C | Relative Humidity < 85% |
|--------|-------------------------|-------------------------|

3.0 Product Option information

| Ordering information | Description |
|----------------------|---|
| GSP-827 | Spectrum Analyzer, 9k~2.7GHz |
| Option 01 | Tracking Generator, 9k ~ 2.7GHz |
| Option 02 | AC/DC/Battery operation power supply with battery pack 90 ~ 260 VAC, 12VDC and Battery operation triple mode Power supply. Battery : Li-Ion x 2. Chargeable with AC line. ⁽¹⁾ |
| Option 03 | Medium stability Time base Temperature: ± 1 ppm Aging: ± 1 ppm/yr |
| Option 06 | GPIB Interface |
| Option 07 | GSC-001: Soft Carrying case |
| Option 08 | General kit Set ADP-002: SMA (J/F) to N (P/M) adaptor $\times 2$ ATN-100: 10dB Attenuator $\times 1$ GTL-303: RF Cable assembly (RD316 + SMA (P) $\times 2$, 60m) $\times 2$ GSC-002: Kit box $\times 1$ |
| Option 09 | CATV kit set ADP-001: BNC (J/F) to N (P/M) adaptor $\times 2$ ADP-101: BNC (P/M) 50 Ω to BNC (J/F) 75 Ω adaptor $\times 2$ GTL-302: RF Cable assembly (RG223 + N(P) $\times 2$, 30cm) $\times 2$ GSC-003: Kit box $\times 1$ |
| Option 10 | RLB kit set GAK-001: Cal. Kit, termination, N, 50 Ω $\times 1$ GAK-002: Cap with chain $\times 1$ GTL-302: RF Cable assembly (RG223 + N (P) $\times 2$, 30cm) $\times 2$ GSC-004: Kit box $\times 1$ |
| Option 11 | GTL-401: DC Power line |

Note (1): The Battery Pack works and be charged with AC line only the DC/AC dual mode power supply is installed. It is not charged at DC operation. It is charged under both power ON and Standby modes.

4.0 First Time Use

The following text assumes that the SAFETY section of this manual has been read carefully and understood.

Each time before the instrument is operated, make sure that it is connected to protective earth. Before establish the connection and measurement, check if the device under test is connected to protective earth as well.

Since the RF measurement is very sensitive, clean connectors on the front panel is very important for the accurate measurement. Regularly cleaning up the connector is strongly recommended.

The main power switch is located on the rear side. Switch it on to activate the Standby mode and the power indicator on the front panel is on with red light. Push and hold the “STBY” button for 2~3 seconds to turn on the unit. The power indicator will turn into green. Pushing and holding the same button turns the unit to standby mode. When the unit is turned into standby or off, the last setting is stored and recalled when it is turned on again.

4.1 Internal calibration signal

A 100MHz -30dBm calibration signal is built-in for internal calibration. Turn it on and off by the following function keys.

Sysetm : Push System key.



F3 : Push F1 key to switch the internal calibration signal ON/OFF.

It is not a well-filtered signal. When the unit is turned on, if 100MHz and harmonics appear on the display, check this signal is ON or OFF first.

4.2 Install and Uninstall the Battery

(1) Remove the cover

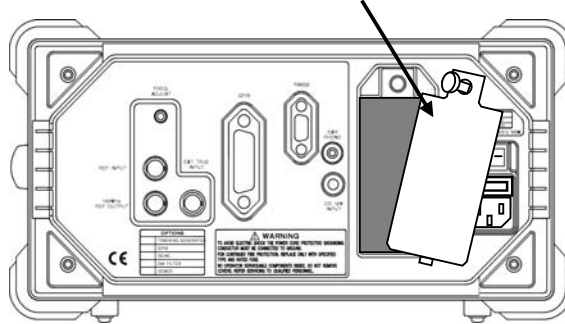

(2) Slide in the batteries

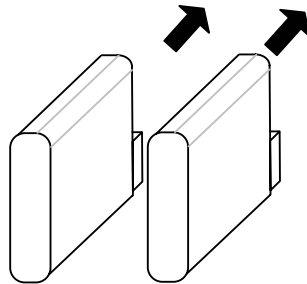

(3) Lock up the cover back

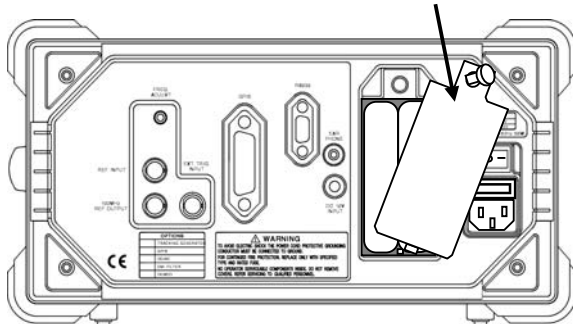

When the battery pack is correctly installed and in use, a symbol  will show up at the top of display.

5.0 Panel Description

5.1 Front Panel Description

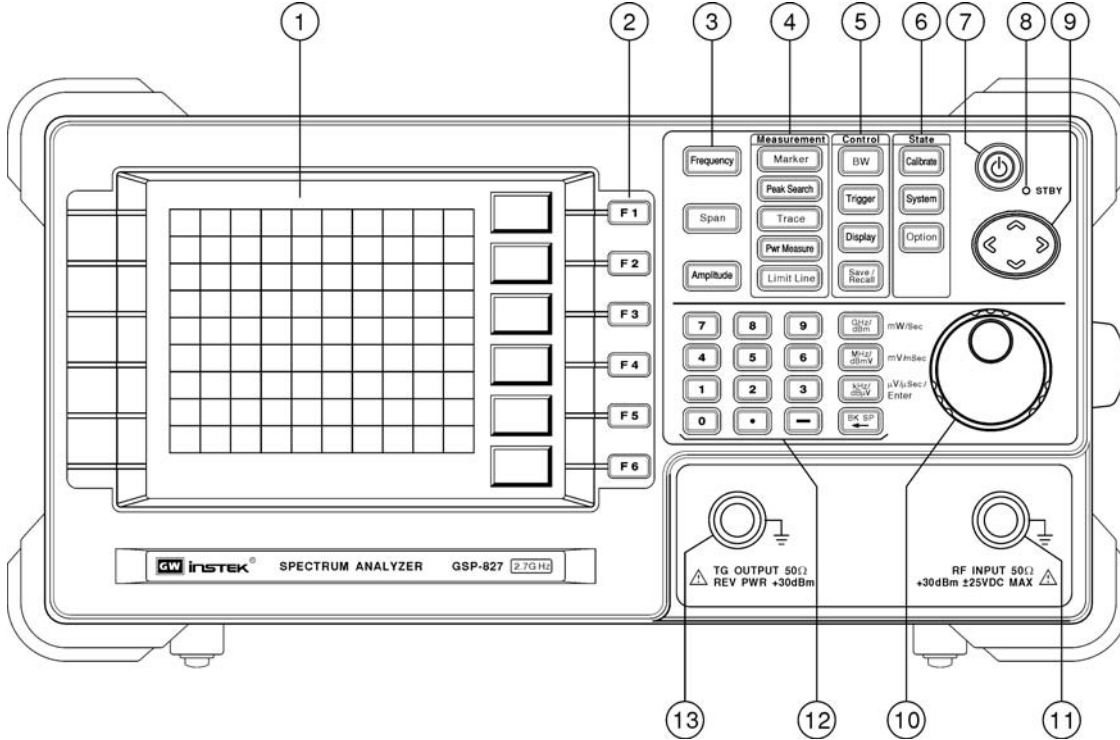

| Item | | Description |
|------|------------------|---|
| 1 | LCD | A 640×480 resolution and monochrome LCD. The Backlight can be switched ON/OFF and Contrast is adjustable. See Display function. |
| 2 | F1-F6 | Soft key linked to the other function keys on the panel. |
| 3 | Main Functions | Including Frequency, Span and Amplitude the most popular keys. |
| 4 | Measurement Keys | Measurement groups including Marker, Peak Search, Trace, Power Measurement and Limit Line. |
| 5 | Control Keys | Control function groups including BW, Trigger, Display and Save/Recall, the BW including RBW, VBW and Sweep Time. |
| 6 | State Keys | State function groups including Calibrate, System and Option. The Calibration function is only for manufacture setting. The Option defines the state of all options. |
| 7 | Power Key | Pushing and holding the key for 2~3 seconds to turn ON/Standby. The main power switch on rear side has to be switched to ON to activate this power key. |
| 8 | Power Indicator | It is green when power is ON and red at Standby. |
| 9 | Arrow key | UP and DOWN arrows make step changes in Frequency, Span and Amplitude. In Frequency change, the frequency step is defined for Frequency step (Frequency >> Step (F4)). In Span, the steps are in 1-2-5 sequence. In Amplitude, the steps are equal to Amplitude scale (Amplitude >> Scale (F3)). The Right and Left keys are mainly used for Calibration. |
| 10 | Scroll Key | Changing the setting in fine step. |
| 11 | RF Input | N type connector for RF measurement input. |
| 12 | Editing keys | Including number, unit, minus sign, back space and enter keys. |
| 13 | TG Output | N type connector for TG synchronized output. |

5.2 Rear Panel Descriptions

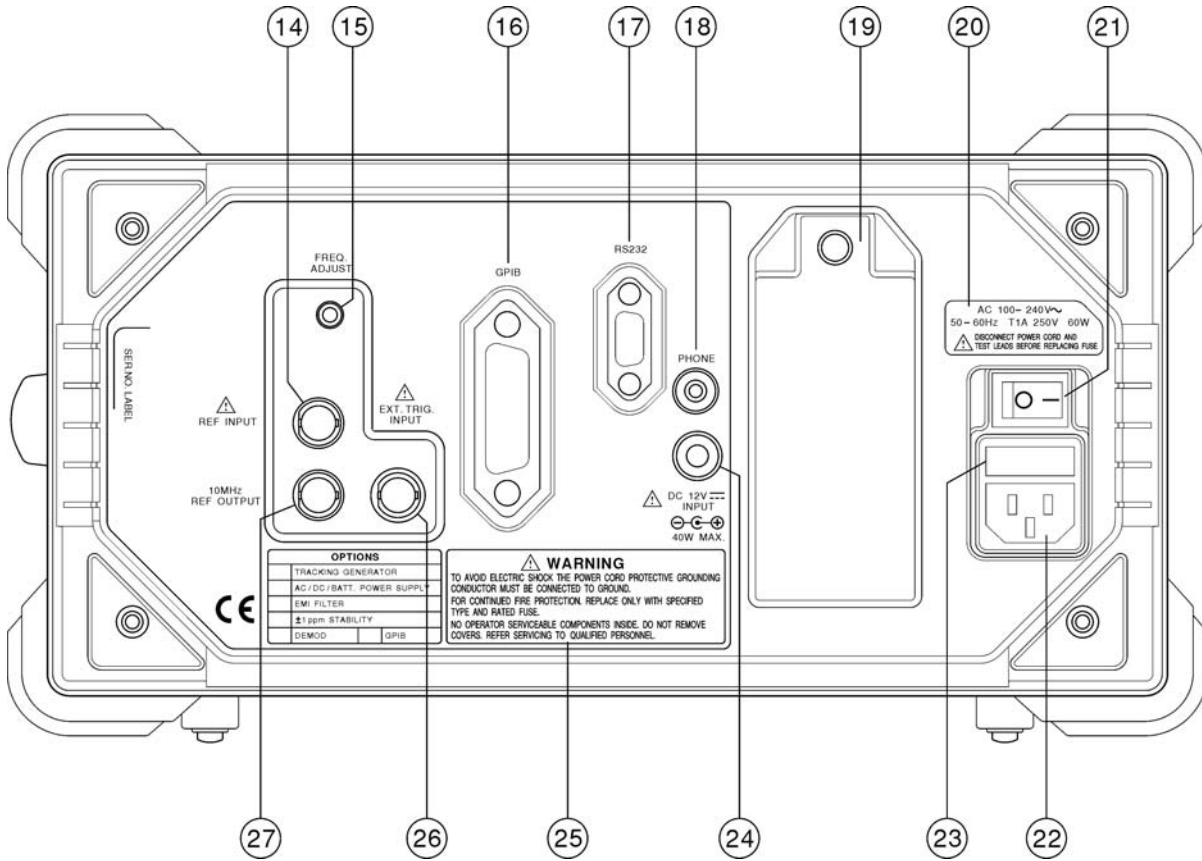

| Item | | Description |
|------|-------------------|--|
| 14 | Ref Input | External reference signal input. When this terminal is fed with an external reference signal, the system frequency is synchronized to it. See Option >> ExtRefFreq function. |
| 15 | Freq. Adjust | Adjustment for internal frequency reference, which allows aligning frequency with the other equipments. |
| 16 | GBIP | GBIP terminal |
| 17 | RS232 | RS232 terminal. |
| 18 | Headphone | Headphone output when the demodulation option is built-in. |
| 19 | Battery Pack Slot | Slot for plugging the battery pack. Rotating the screw on the top of battery cover counterclockwise to move the cover. Installation is easily done by sliding batteries in and locking up the cover. |
| 20 | Panel label | Fuse selection guide. |
| 21 | Power Switch | Main AC Power switch. |
| 22 | AC Input | AC Input. |
| 23 | Fuse Socket | Fuse socket. |
| 24 | DC Input | DC 12V input. |
| 25 | Panel Label | Usage warning. |
| 26 | Trigger Input | External Trigger input. See Trigger >> External function. |
| 27 | 10MHz Ref Output | 10MHz output allows synchronizing with the other equipment. |

6.0 Quick use guide

6.1 General Description

The quick use guide provides the information of measurement-oriented operation. Every operation is titled with a measurement demand and followed by the corresponding operation sequence of the keys on the front panel and terminals on the rear panel.

6.2 Guide

6.2.1 Find the signal

- (1) The frequency is unknown: Use Full Span to scan entire frequency range.

| Function key | Description |
|----------------------------|---|
| Span | Select the Span functions. |
| F4<Full Span> | Select the Full Span to scan the entire measuring band. |

- (2) The frequency is known: Specify the frequency directly.

| Function key | Description |
|-------------------------|---|
| Frequency | Select the Frequency functions. |
| F1<Center> | Specify the Center Frequency. |
| N, ... , MHz | Key in the specific frequency by using numerical and unit keys. |
| Span | Activate the Span to set the frequency range. |
| M, ... , MHz | Key in the frequency range or |
| Spinner | Rotate Spinner to change the Span in 1-2-5 sequence. |

Or set the start/ stop frequency.

| Function key | Description |
|-----------------------------|---|
| Frequency | Select the Frequency functions. |
| F2 <Start> | Specify the Center Frequency. |
| N, ... , MHz | Key in the specific frequency by using numerical and unit keys. |
| F3<Stop> | Activate the Span to set the frequency range. |
| M, ... , MHz | Key in the frequency range. |

6.2.2 Find Peak signal

- (1) In Frequency function

| Function key | Description |
|----------------------------------|--|
| F5 <Peak to Center> | Set the Center frequency to the peak signal frequency, so that the peak signal will be shown at up right of the central display. |

(2) In Peak Search function with Marker

| Function key | Description |
|--------------------|--|
| Peak Search | One marker will automatically find the peak signal and show the frequency and amplitude. |

6.2.3 Track Peak signal

| Function key | Description |
|-------------------------------|--|
| Peak Search | One marker will automatically find the peak signal and show the frequency and amplitude. |
| F6<Track ON/OFF> | The marker will continuously find the peak signal and move to the center when the track is on. |

Or manually operate one step a time.

| Function key | Description |
|-----------------------------------|--|
| Peak Search | One marker will automatically find the peak signal and show the frequency and amplitude. |
| F2<Marker to Center> | The marker will move frequency marked to the center. |

6.2.4 Make correct amplitude measurement

| Function key | Description |
|-----------------------------|--|
| Amplitude | Select the amplitude relative functions. |
| F1 <Ref Level> | Set the top level of display. Note: The input signal exceeding the reference level will cause error in the harmonic related measurement. |
| F3 <Scale> | Select the scale to zoom in/out the amplitude for observation. |
| F4 <Unit> | Select the unit as wanted. The scaling between the units is automatically done. |

6.2.5 75Ω system measurement

| Function key | Description |
|-------------------------------|---|
| Amplitude | Select the amplitude relative functions. |
| F6<More> | Look for more functions. |
| F1 <Input Z> | Switch the input impedance to 75 ohm. |
| F2 <Input Z CAL> | Calibrate the deviation caused by 75Ω impedance if necessary. |

6.2.6 Multi-marker operation

| Function key | Description |
|---------------------------------|--|
| Marker | Select the Marker relative functions. |
| F1 <Marker> | Select the active marker by keying in marker number. |
| F2 <Marker ON/OFF> | Toggle the specified Marker ON/OFF. |
| N, ... , MHz | Key in the specific marker frequency by using numerical and unit keys. Repeating the above procedure can turn on markers from 0 to 9. |

6.2.7 Delta-Marker operation

| Function key | Description |
|------------------------------------|---|
| Marker | Select the Marker relative functions. |
| F1 <Marker> | Select the active marker by keying in marker number. 0 means marker 10. |
| 1 | Key in 1 to take marker 1 as example. |
| F2 <Marker ON/OFF> | Set Marker 1 ON. |
| N, ... , MHz | Set frequency of marker 1. |
| F1 <Marker> | Select the second marker, marker 2 here for example. |
| 2 | Key in 2 to take marker 2 as example. |
| F2 <Marker ON/OFF> | Set Marker 2 ON. |
| N, ... , MHz | Set frequency of marker 2. |
| F3 <Normal, Δ Mkr> | Set Marker2 as Δ marker. |
| 1 | Select the Reference Marker due to Mkr2. Key in 1 to take marker 1 as reference marker. |

Note: The table will show the level and frequency in delta reading. In this example, the marker table will show as follows.

| Marker | Level | Freq(MHz) |
|--------|-------|-----------|
| 1 | ll | f1 |
| 3 Δ1 | Δll3 | Δf13 |

Which means marker 3 is the Δ Mkr due to Mkr1.

6.2.8 Peak Hold, Average and Freeze the measurement

| Function key | Description |
|------------------------------------|--|
| Trace | Select the trace relative functions. |
| F3 <PkHold> | Switch the peak hold function ON/OFF. |
| F4 <AVG > | Switch the Average function ON/OFF. When it is ON, key in the average times. |
| F5 <Freeze> | Switch the freeze function ON/OFF. |

6.2.9 ACPR Measurement

| Function key | Description |
|------------------------------------|--|
| Pwr Measure | Select the power measurement relative functions. |
| F4 <Setup> | Setup the Power Measurement parameters. |
| F1 <CH BW> | Define the channel bandwidth. |
| F2 <CH SPC> | Define the channel space. |
| F4<ADJ CH OFFSET> | Define the adjacent channel parameters. |

| | |
|--------------------------------|---|
| F1<ADJ CH BW1> | Define the bandwidth of adjacent channel 1. |
| F2<ADJ CH Offs 1> | Define the offset from the adjacent channel 1. |
| F3<ADJ CH BW2> | Define the bandwidth of adjacent channel 2. Ignore this step if only one adjacent channel is measured. |
| F4<ADJ CH Offs 2> | Define the offset from the adjacent channel 2. Ignore this step if only one adjacent channel is measured. |
| F6 <Return> | Exit the adjacent channel setup. |
| F6 <Return> | Exit the setup submenu. |
| F1 <ACPR ON> | Activate the ACPR measurement. |

6.2.10 OCBW Measurement

| Function key | Description |
|---------------------------|--|
| Pwr Measure | Select the power measurement relative functions. |
| F4 <Setup> | Setup the OCBW measurement parameter. |
| F1 <CH BW> | Define the channel bandwidth. |
| F3 <OCBW> | Define the power percentage |
| F6 <Return> | Exit the setup submenu. |
| F2 <OCBW ON> | The OCBW measurement includes the total power in channel and bandwidth occupied of the percentage power. |

When the channel parameters are first set, there are some keys offering the convenient way to measure the other channels.

| Function key | Description |
|-------------------------|---|
| Pwr Measure | Select the power measurement relative functions. |
| F5 <CH Up> | Measure the next channel. The Center frequency will increase one channel space. |
| F6 <CH Dn> | Measure the previous channel. The Center frequency will decrease one channel space. |
| F3 <CH BW> | Define the channel bandwidth, same as the <CH BW> in <Setup> |

6.2.11 Pass/Fail test by Limit Line

| Function key | Description |
|---------------------------------|---|
| Limit Line | Select the Limit Line relative functions. |
| F1 <HLimit ON/OFF> | Activate the high limit line. |
| F2 <LLimit ON/OFF> | Activate the low limit line. |
| F4 <Pss/fl ON/OFF> | Activate the Pass/Fail test. The “PASS” and “FAIL” messages will automatically appear underneath the trace. |

6.2.12 Edit the Limit Line,

| Function key | Description |
|-----------------------------------|---|
| Limit Line | Select the Limit line relative functions. |
| F3 <Edit> | Select limit line editing. |
| F1 <Limit Upper> | Toggle the editing between high and low limit line. |
| Arrow Keys | Use ^ v > < arrow keys to mark and modify the existed points. |
| F2 <Insert> | Insert a point at where the point is marked. |
| F3 <Delete> | Delete a point at where the point is marked. |
| F4 <Undo> | Undo the previous edit step. Only one step is reserved. |
| F6 <Return> | Exit the limit line editing. |

6.2.13 Change RBW, VBW and Sweep time

| Function key | Description |
|----------------------------------|--|
| BW | Activate the power measurement relative functions. |
| F1 <RBW Auto> | Switch RBW between Auto and Manu mode. In auto mode, RBW is coupled with Span; in manual mode, use ^ and v arrow keys to select RBW as wanted. |
| F2 <VBW Auto> | Switch VBW between Auto and Manu mode. Use ^ and v arrow keys to select VBW as wanted in manual mode. |
| F3 <SwpTm Auto> | Switch Sweep Time between Auto and Manu mode, key in the sweep time as wanted in manual mode. |
| F4 <All Auto> | Set all RBW, VBW and sweep time to auto mode. |

6.2.14 Trigger by input signal level

| Function key | Description |
|-----------------------------------|---|
| Trigger | Select the trigger mode functions. |
| F2 <Video Level> | Select level-on-display as trigger source. Key in the level to trigger the sweep. |

| | |
|---------------------------------|--|
| F6 <Trigger Setup> | Set the frequency of trigger source. The default is Center frequency. |
| N, ... MHz | Key in the frequency. |
| F6 <Return> | Exit the trigger setup submenu. |
| F4 <Singl> | Select single trigger, there will be only one sweep.. Otherwise, it will have continuous sweeps. |
| F5 <Trigger Delay> | Define delay between the trigger condition and sweep. |
| F2 <Video Level > | Exit the Single trigger mode. |
| F1 <Free Run > | Exit the trigger mode. |

6.2.15 Trigger by Externally stimulus signal

| Function key | Description |
|-------------------------|--|
| Trigger | Select the trigger mode functions. |
| F3 <Exter> | Select the external trigger input (on the rear panel) as the trigger source. |

Note: The Single trigger, trigger delay, trigger setup and exiting single trigger operations are same as previous “Video Level” mode.

6.2.16 Observe two sweeps (ex, 2nd harmonic) by Dual Windows

| Function key | Description |
|--------------------------|---|
| Display | Select the Display relative functions. |
| F4 <Split > | Split the window in dual windows. |
| F5 <Upper> | Select the upper window as active one. All the measurement configurations are due to upper one. In harmonic measurement example, set the fundamental frequency as the center frequency here. |
| F6 <Lower > | Select the lower window as the active one. All the measurement configurations are due to lower one. In harmonic measurement example, set the harmonic frequency as the center frequency here. |

6.2.17 Configure Display setting

| Function key | Description |
|---------------------------------|--|
| Display | Activate the power measurement relative functions. |
| F1 <LCD Cntrst > | Rotate <i>Spinner</i> to adjust LCD contrast. |
| F2 <Bklight> | Switch the backlight ON/OFF. |
| F3 <Invert screen> | Invert the screen. |

6.2.18 Save measurement/setup to Memory

| Function key | Description |
|----------------------------------|--|
| Save/Recall | Select the Save/Recall relative functions. |
| F1 <Save Trace> | Save the trace. |
| F5 <From Live> | Select the measuring trace to save. |
| Up/Down Arrows or Spinner | Select the memory to save. The memory list is on the LCD display. |
| Right Arrow | Move the cursor to the Name filed of memory. |
| Up/Down Arrows or Spinner | Use Up/Down arrow keys to select the alphabet to name the stored data. Repeat these four arrow keys to complete the name. Or |
| Enter | Press Enter to complete the operation. |

Note: The Setup is saved simultaneously when the trace is saved.

6.2.19 Recall trace/setup to Memory

| Function key | Description |
|----------------------------------|---|
| Save/Recall | Select the Save/Recall relative functions. |
| F2 <Recall Trace> | Activate the trace/setup recall function. |
| Up/Down Arrows or Spinner | Select the memory to recall. The memory list is on the LCD display. |
| F5 <to Tr A> | Select trace A as recalling destination. Or |
| F5 <Setup> | Select recalling the Setup. |
| Enter | Press Enter to complete the operation. |

6.2.20 Turn ON/OFF the Internal calibration signal

| Function key | Description |
|---------------------------|--|
| System | Select the System functions. |
| F3 <RefSig > | Switch the internal calibration signal 100MHz -30dBm ON/OFF. |

6.2.21 Calendar/Clock setting**Date setting**

| Function key | Description |
|--------------------------------|---|
| System | Select the System relative functions. |
| F5 <System clock> | Select to set the real time clock inside. |

| | |
|--------------------------------------|---|
| F1 <Date> | Set date information. |
| F1 <Year> | Key in the Number of year and press Enter key. |
| F2 <Month> | Key in the Number of month and press Enter key. |
| F3 <Day> | Key in the Number of day and Enter press key. |
| F4 <Day of week> | Key in the Number of day of week and press Enter key. |
| F6 <Return> | Exit the Date setting. |

Time setting

| Function key | Description |
|---------------------------------------|---|
| System | Select the System relative functions. |
| F5 <System clock> | Select to set the real time clock inside. |
| F2 <Time> | Set time information. |
| F1 <Hour> | Key in the Number of hour and press Enter key. The hour is in 24 hour system. |
| F2 <Minute> | Key in the Number of minute and press Enter key. |
| F3 <Second> | Key in the Number of second and press Enter key. |
| F6 <Return> | Exit the time setting. |

6.2.22 Preset system

| Function key | Description |
|--|---------------------------------------|
| System | Select the System relative functions. |
| F6 <More> | Look for more functions. |
| F2 <System Preset> | Preset the system. |
| F6 <Return> | Exit the submenu. |

6.2.23 System information

| Function key | Description |
|----------------------------------|---------------------------------------|
| System | Select the System relative functions. |
| F6 <More> | Look for more functions. |

| | |
|---------------------------------|--|
| F3 <System Config> | The system configuration will be shown up, including serial number, S/W and F/W version number, Options, Los status, reference signal source and status. |
| F6 <Return> | Exit the submenu. |

6.2.24 Synchronized by External Reference Signal

| Function key | Description |
|----------------------------------|--|
| Option | Select the Option relative functions. |
| F3 <ExtRef Freq> | Select the external reference signal source. |
| Up/Down Arrows or Spinner | Select the reference signal frequency. |
| - | Connect the reference signal source to the BNC terminal “Ref Input” on the rear panel. |

6.2.25 Synchronize other equipments

Connect the “10MHz Ref Output” terminal on the rear panel to the “External Ref. Input” of following equipment directly.

6.2.26 Tracking Generator Operation (option)

| Function key | Description |
|-----------------------------|--|
| Option | Select the Option relative functions. |
| F1 <TG> | Select the Tracking Generator. |
| F2 <TG Level > | Set the TG output Level. |
| F1 <TG ON> | Switch the TG ON. |
| F3 <Normal> | Perform the Normalization function before connecting the DUT if necessary. |
| F5 <Ref Value> | This function allows normalization on the specific level for extra gain or loss. |

7.0 Menu Tree

The menu tree gives a brief overview of user interface structure. The more detailed explanation for each function key is described in this Chapter 7.

7.1 Main Function

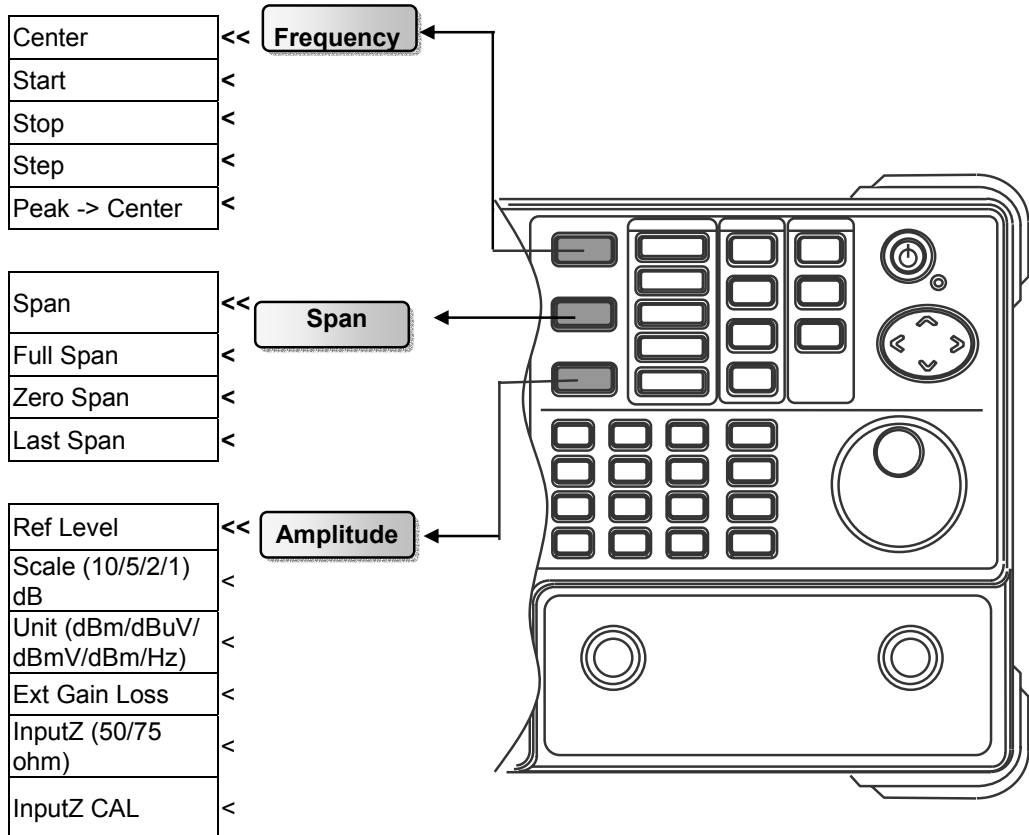

7.2 Measurement Function

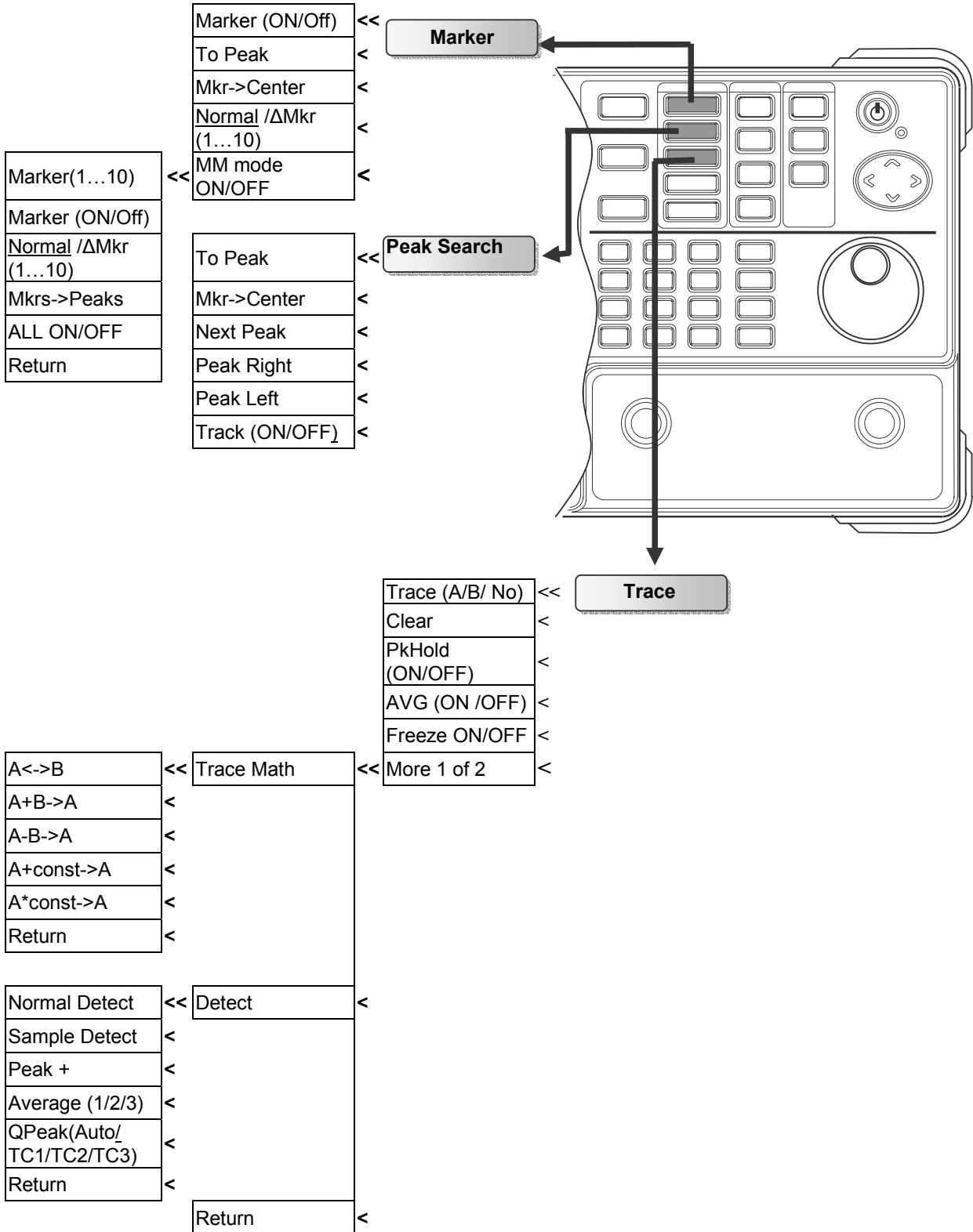

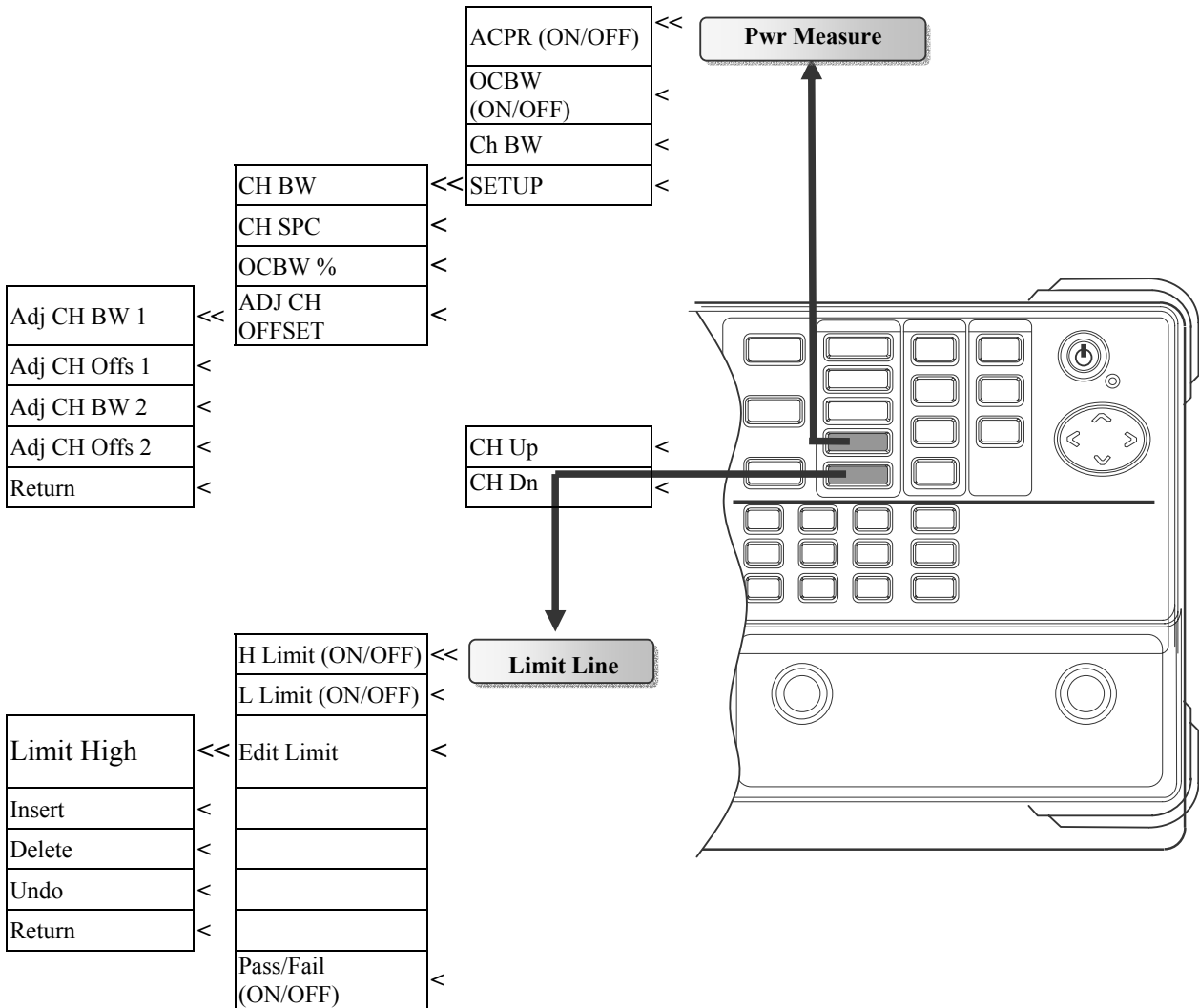

7.3 Control Function

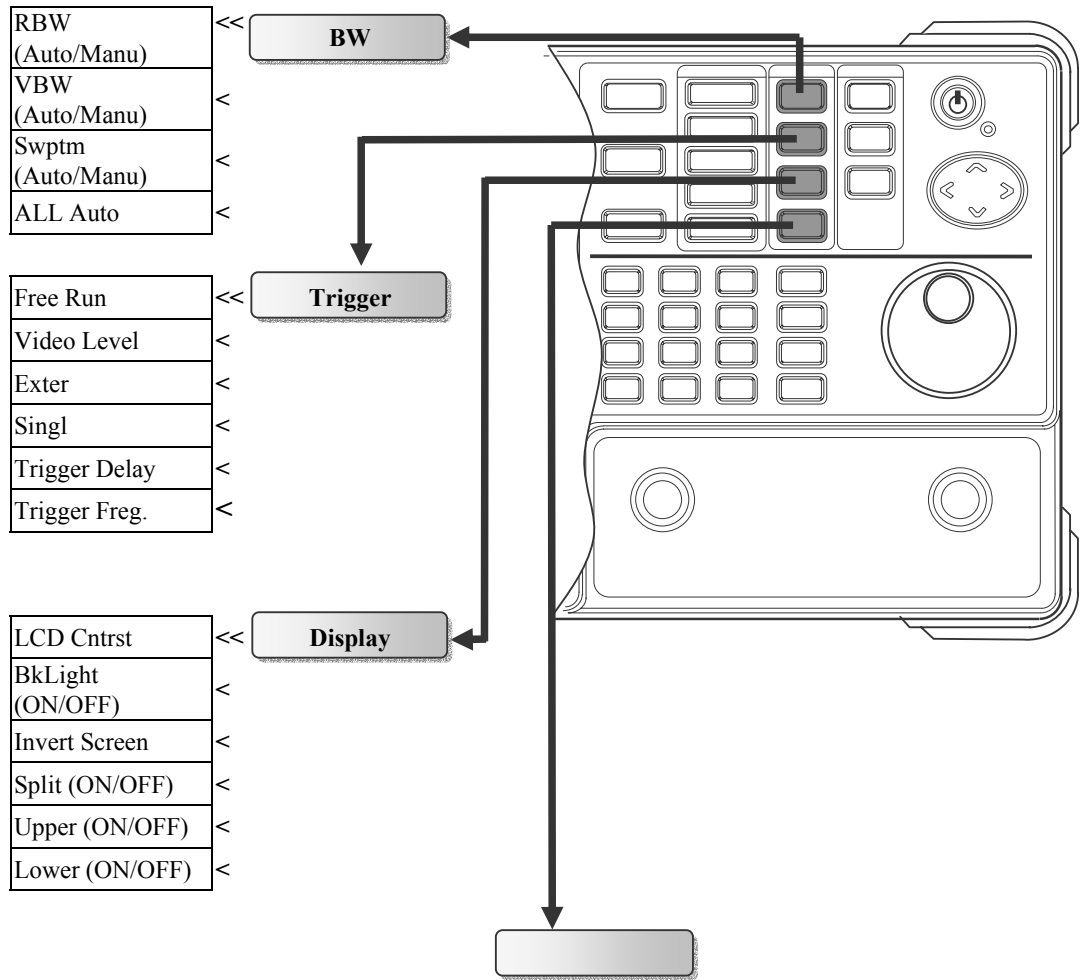

7.4 State Function

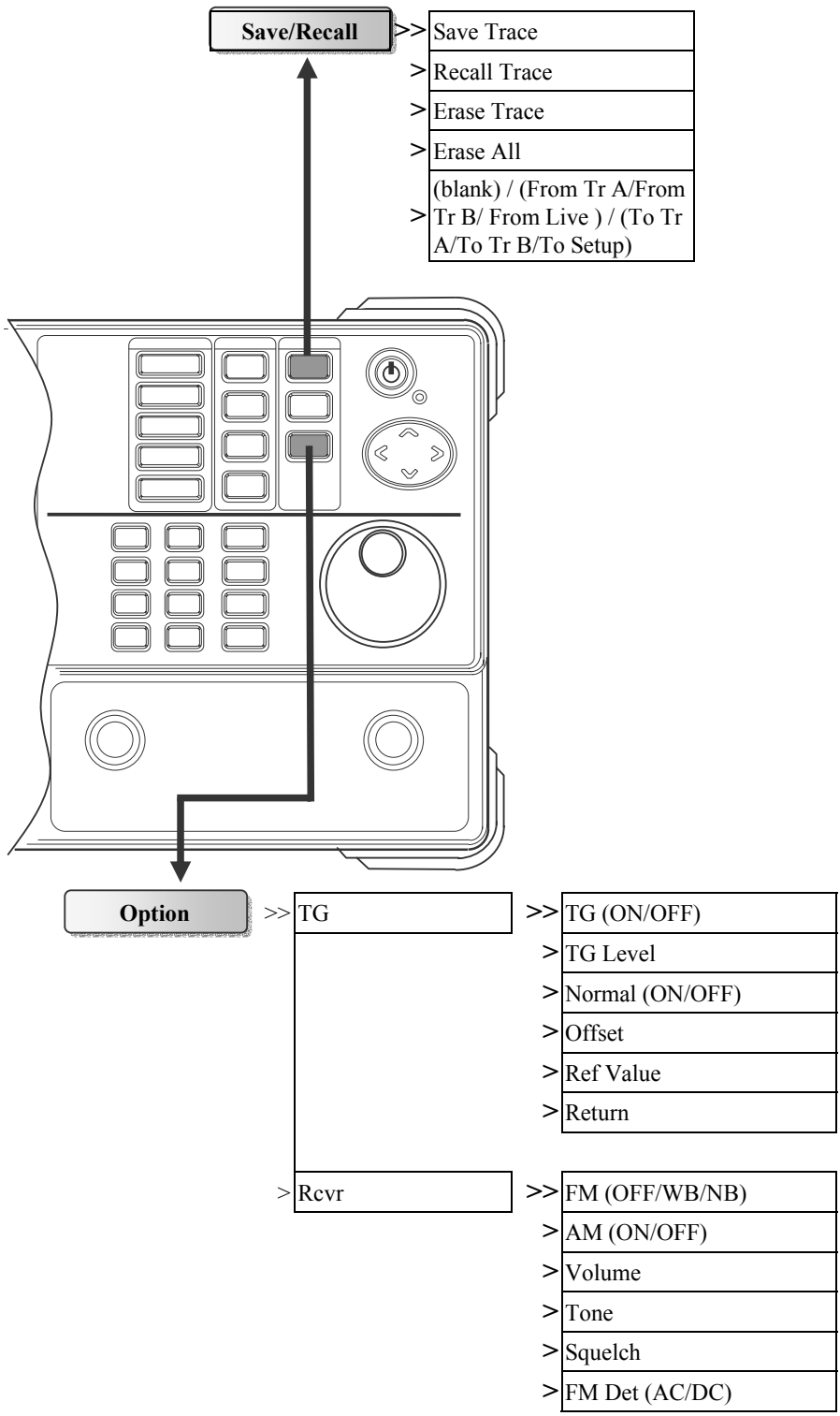

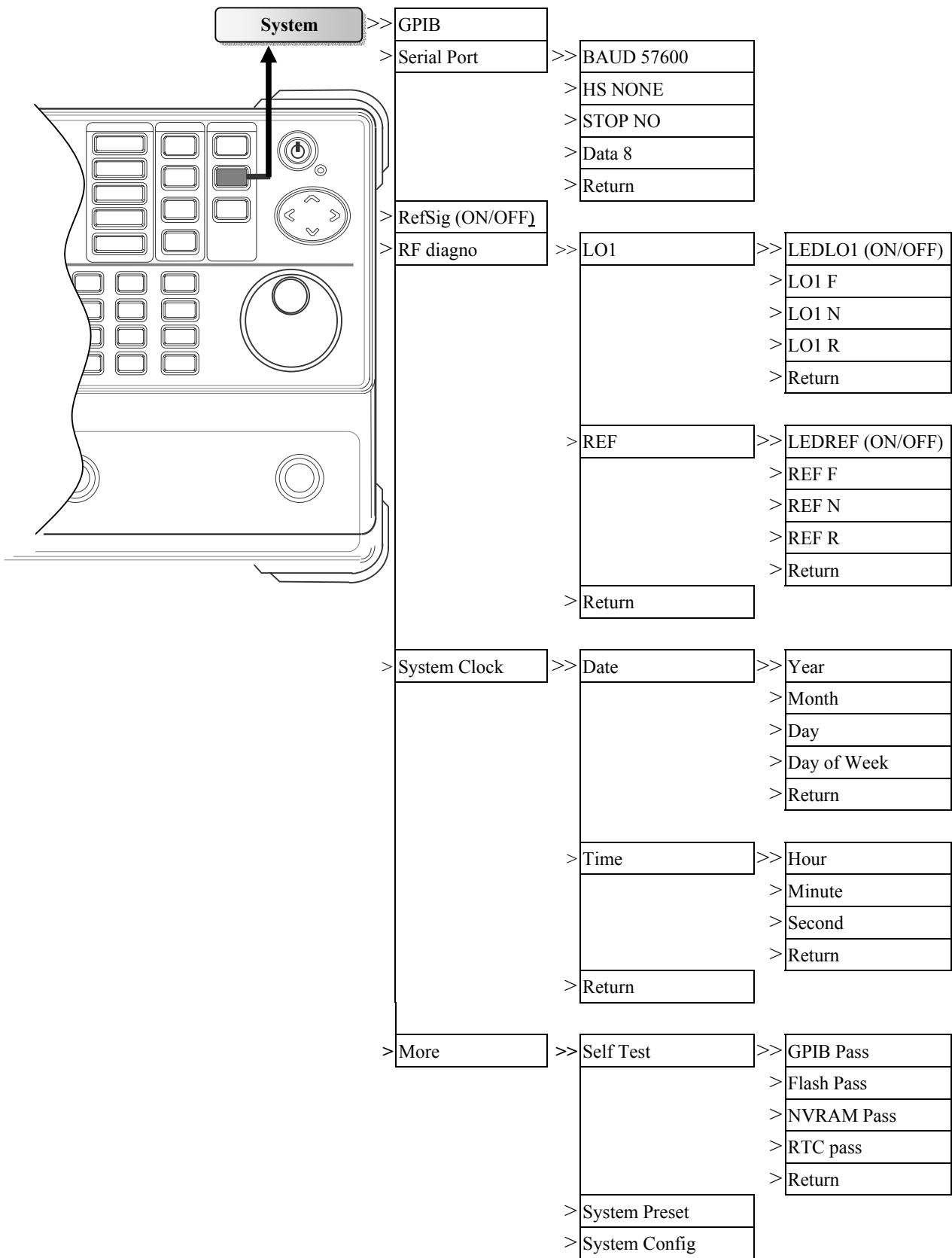

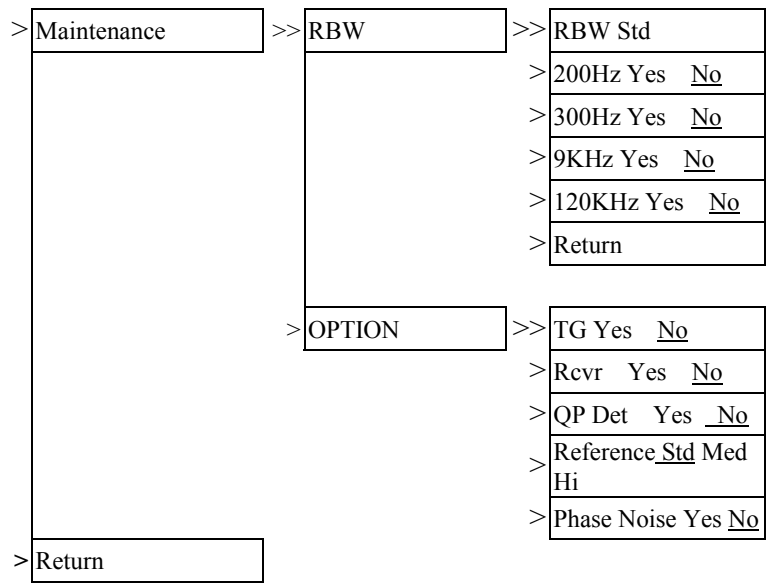

8.0 Operation

In this chapter the detailed information of operation is introduced.

8.1 Main Functions

8.1.1 Frequency Functions

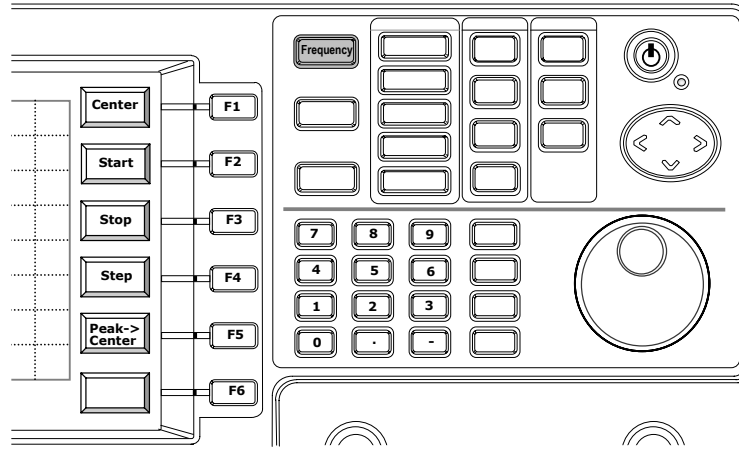

There are two methods to set the measuring frequency, **Center/Span** and **Start/Stop**. **Span** means the measuring bandwidth. **Center** and **Span** are usually used in the situation that the frequency under test is known. **Start** and **Stop** are used for the measured frequency of a specific range.

Step and **Peak to Center** are functions to make easy operation in some case. When the step is defined, the frequency entry will change for the step number. **Peak to Center** will find the peak signal on display and then change the center frequency to the frequency of peak signal. **Peak to Center** will not activate the marker.

Center Frequency

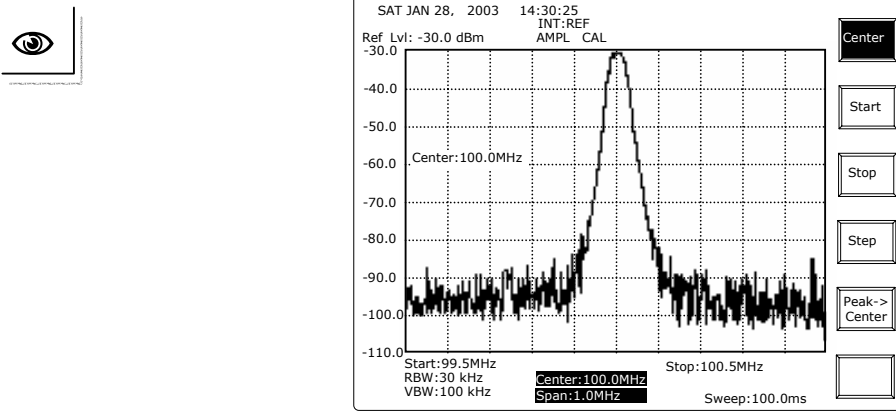
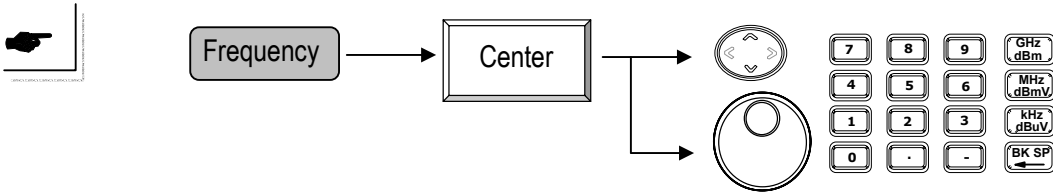

UP/ DOWN: To change frequency for one step size which is defined in **Step** function.

Scroll: To change the **Center frequency** 1/500 span for every movement.

For example, center frequency is 100MHz, span is 10MHz. Every movement of scroll key will change 20kHz. Clockwise rotation increases the setting and counterclockwise rotation decreases the setting.

Editing: Directly specify the center frequency. The back space key **BK SP** can erase the last number.

Note: Refer to **Span** function to see the operation.

Start/ Stop Entry

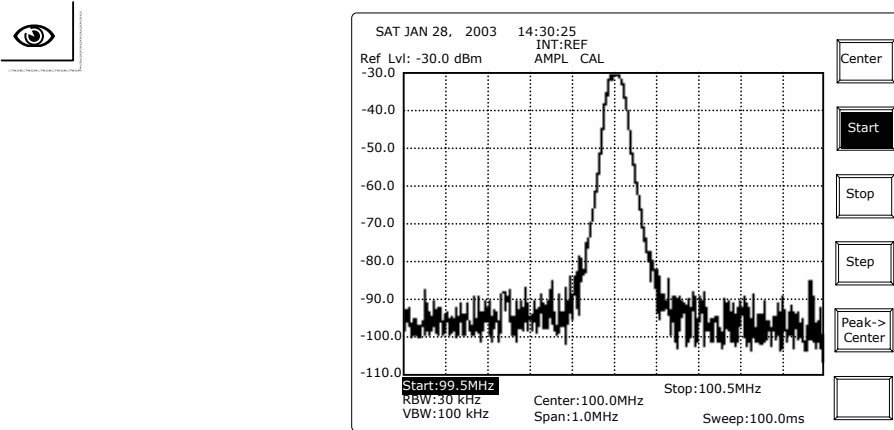
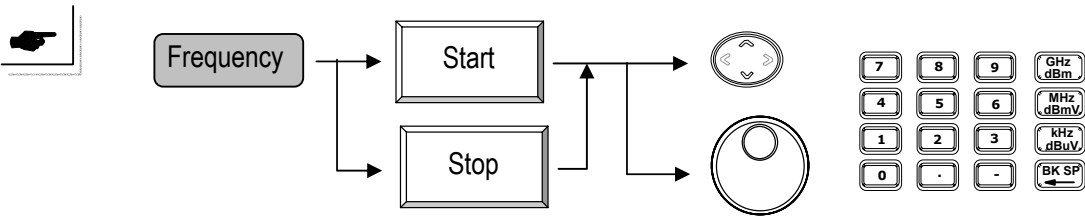

UP/ DOWN: To change frequency for one step size which is defined in **Step** function.

Scroll: To change the frequency 1/500 Span for every single movement. Clockwise rotation increases the setting while counterclockwise rotation decreases the setting.

For example, the start frequency is at 95.0MHz and stop frequency is at 105.0MHz, the span is at 10MHz, the first clockwise movement of scroll key will change Start Frequency to 99.52MHz. The second movement will change the start frequency to 95.03996MHz since the span was changed to 9.98MHz (105.0-95.02).

Editing: Directly specify the center frequency.

The relation between Center/Span and Start/Stop are as follows.

$$StartFrequency = Center - \left(\frac{Span}{2} \right) \text{ and } StopFrequency = Center + \left(\frac{Span}{2} \right)$$

Step

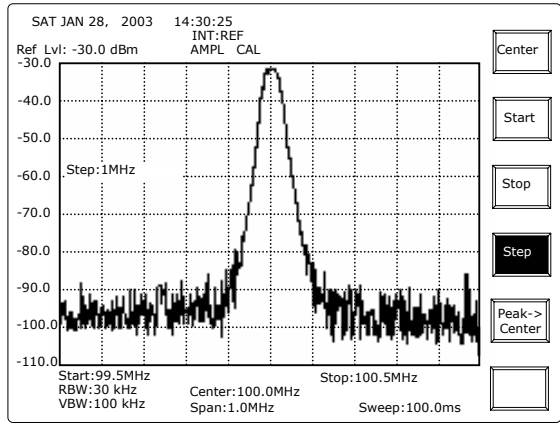
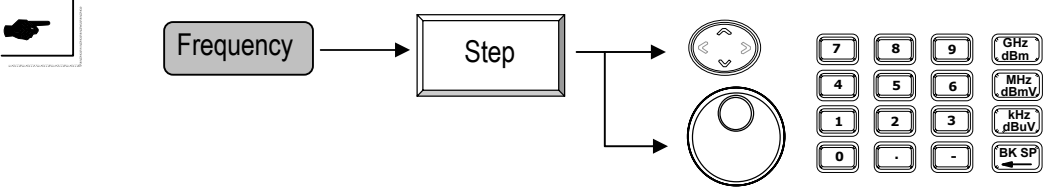

UP/DOWN: To change the Step by 1/10 of span each time.

Scroll: To change the Step by 1/10 Span for every key pushing. Clockwise rotation increases the setting while counterclockwise rotation decreases the setting.

For example, if the span is 100MHz, UP/DOWN and Scroll keys will change the frequency 10MHz for every key pushing or scroll movement.

Editing: To specify the center frequency directly.

Peak->center

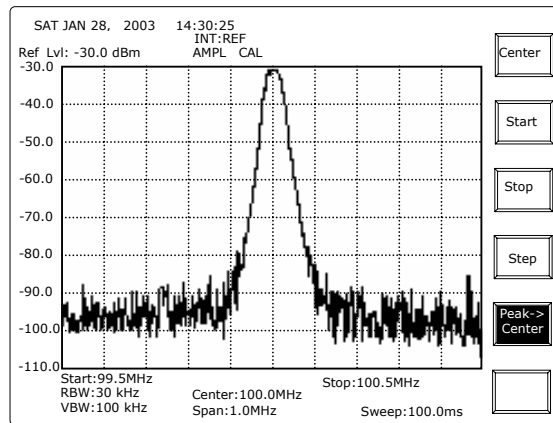
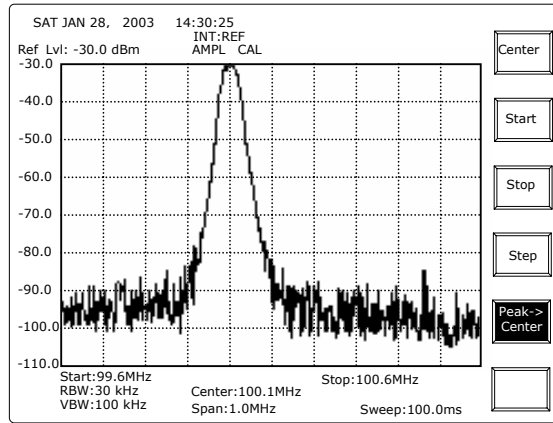
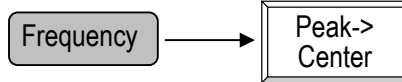

Peak to Center will find the frequency of peak signal first, and then change the Center frequency to the peak frequency. Performing this function will not enable all marks.

8.1.2 Span Functions

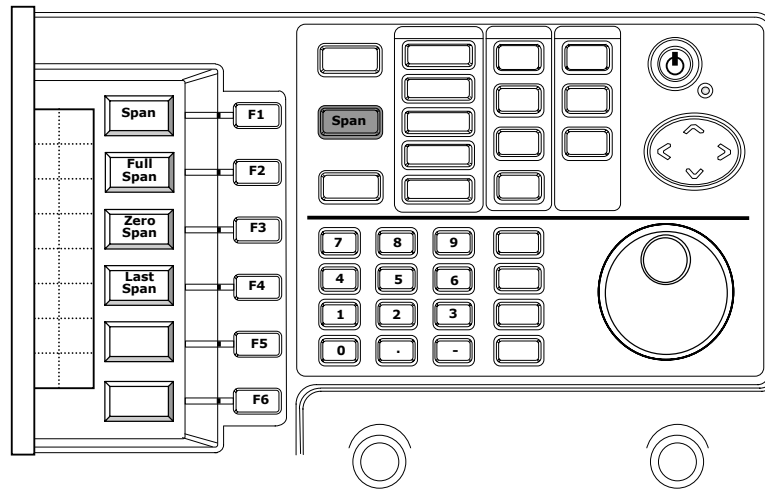

Span is to define the frequency range of measurement. When all the **BW** settings (RBW, VBW and Sweep Time) are in **Auto** mode, BW settings is changed following the change of the span. Please refer to the BW function to see the details.

Full Span will set the Span at 2700MHz, in other words, the start frequency is at 0 and stop is at 2700MHz. **Zero Span** will stop the frequency sweep and stay at the Center frequency. In other words, the unit only measures the center frequency. When the tracking generator is in use, it will generate a fixed frequency signal not sweeping signal. Refer to **TG** (Option→TG) function for details. **Last Span** will let Span return to the last setting. Note that only one last setting will be kept.

SPAN

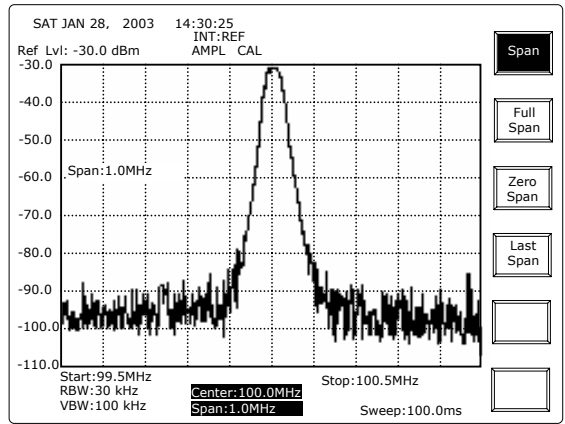
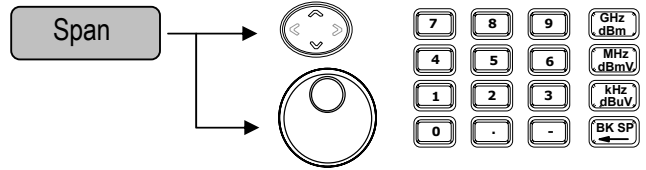

UP/DOWN and **Scroll**: To change the **Span** in 1-2-5 sequence. The example is like ...1M, 2M, 5M, 10M, 20M, 50M,..., and so on. The Span selection prior to 1kHz is Zero, and the last Span after 2.5GHz is at 2.7GHz.

Editing: Directly specify the center frequency. The back space key BK SP can erase the last number.

Full Span

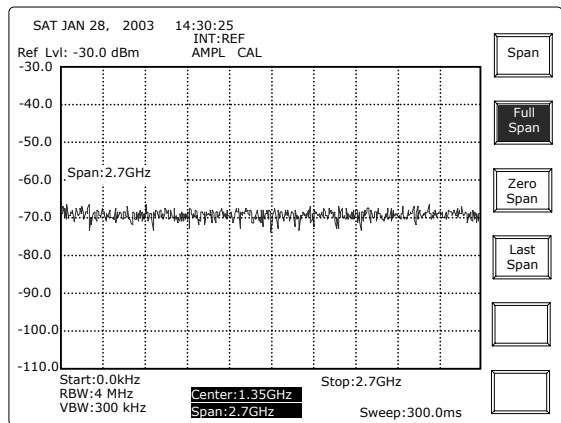

Zero Span

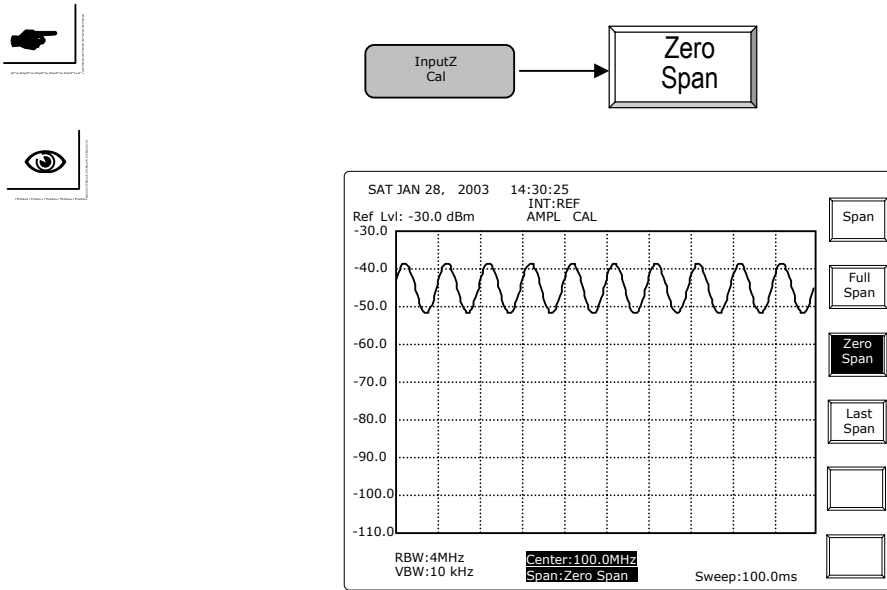

When Zero Span is performed, the measuring frequency will stop sweeping, and only fixes on Center frequency. An example of AM (amplitude modulation) signal is described above. The modulating signal is at 100Hz sine wave. Since the measuring frequency is fixed, the display will present the amplitude variation of AM signal, which is at 100Hz in this case.

Last Span

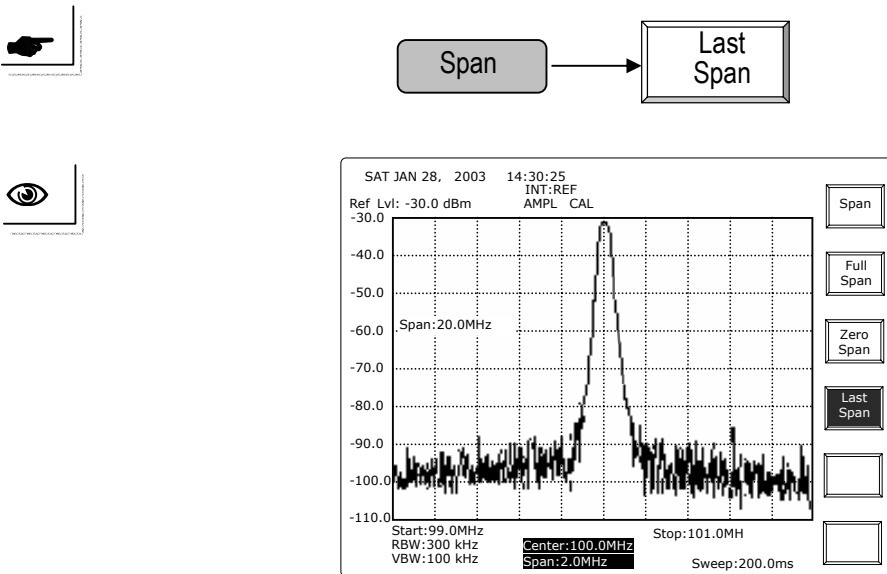

Return to the last span by using this key.

8.1.3 Amplitude

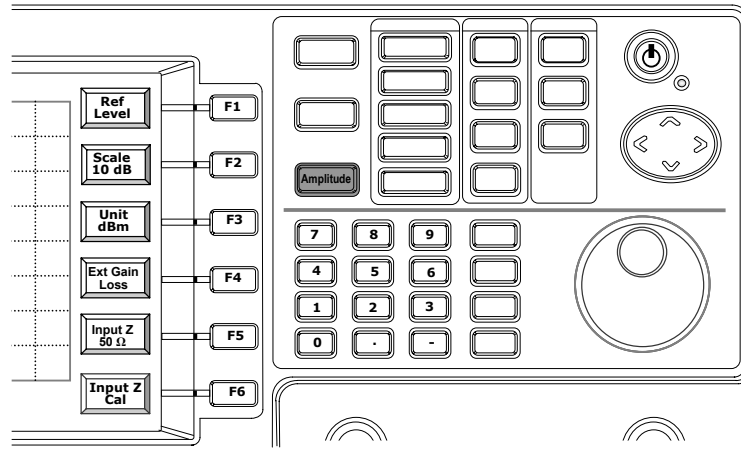

Reference Level is the top level on the display. The level of input signal is recommended to be under the reference level to have accurate result.

The **Scale** can be switched in 10-5-2-1 dB sequence. Note that the accuracy will not change following the scale change. It is a graphical Zoom in function.

Unit includes dBm, dBuV, dBmv and dBm/Hz. There is a transformation factor 107 between dBm and dBuV under 50Ω system, and 47dB factor between dBm and dBmV. The dBm/Hz is the so-called noisy marker which normalizes the reading into 1Hz bandwidth.

ExtGain/Loss allows the amplitude offset caused by user's application.

InputZ can toggle the input impedance between 50Ω and 75Ω. Note the 50Ω and 75Ω switch here is a software adjustment. **Input Z Cal** offers the compensation entry of the 75Ω adaptor. The ideal number is at 5.9dB

Reference Level

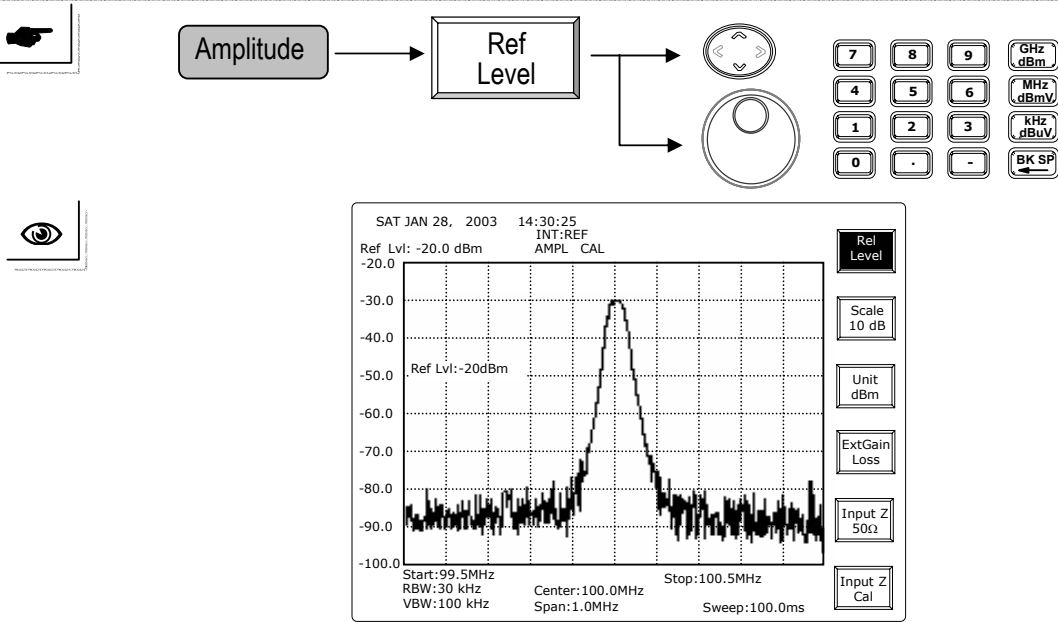

UP/DOWN and Scroll: To change the Reference Level one scale a time. If the scale is at 10dB, the UP key will increase the RefLvl from -30dBm to -20dBm in the above case.

Numerical: Using the numerical and unit keys can specify the reference level from -50 dBm to +20dBm in one dBm resolution.

Scale

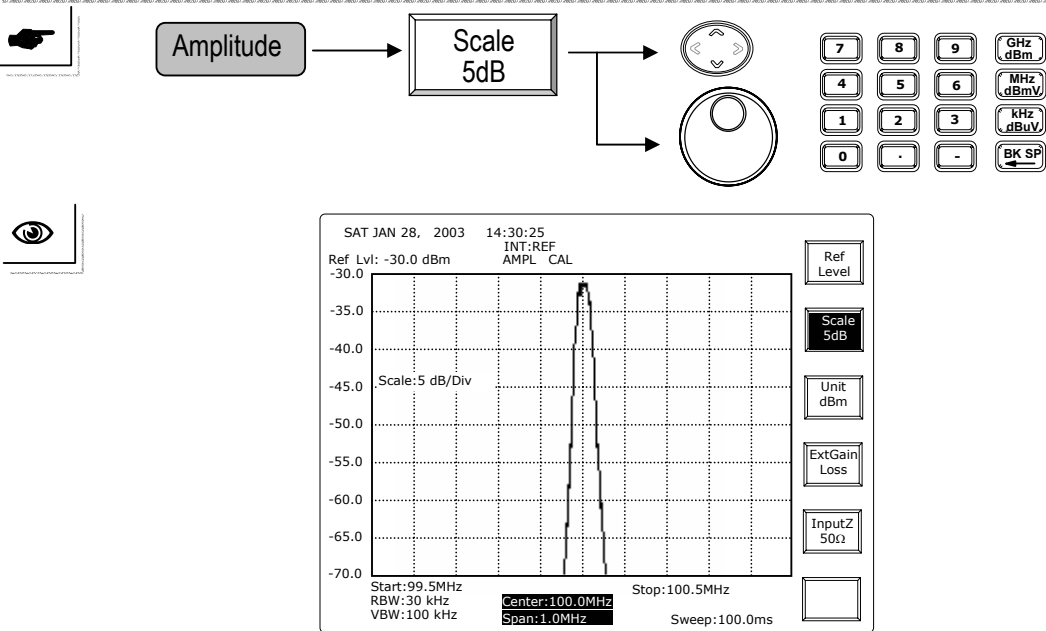

UP/DOWN and Scroll keys switch the scale in 10-5-2-1 sequence.

Editing: The editing entry will select the closest scale to 10-5-2-1 one.

Unit

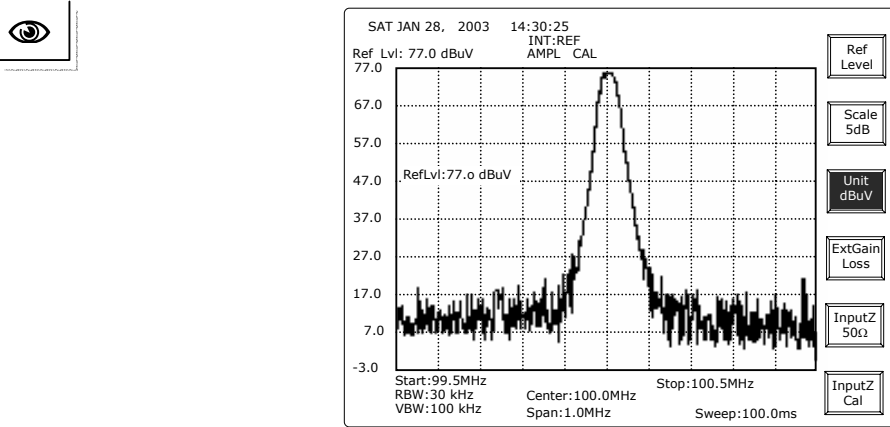

Repeat this key will switch the unit in dBm, dBuV, dBmV and dB/Hz sequence.

External Gain Loss offset

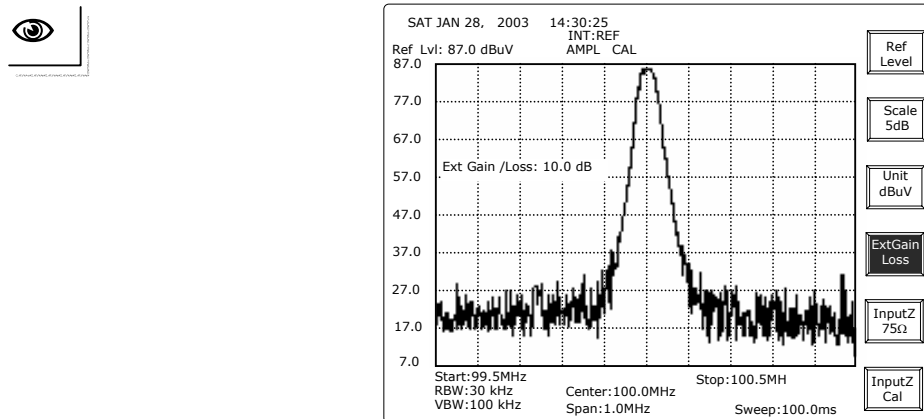
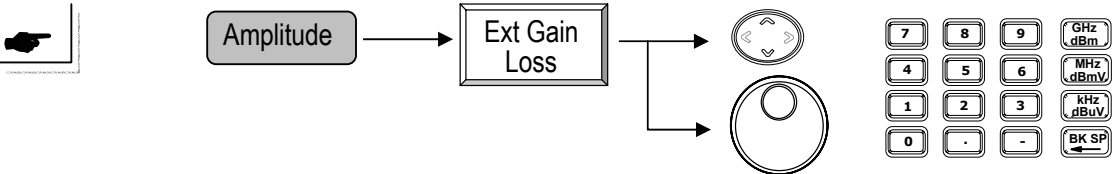

UP/DOWN and **Scroll**: To change offset by 0.1dB for every move.

Editing: To adjust the offset from -99.0 to 99.0dB in 0.1 dB resolution.

Input Z 50Ω/ 75Ω

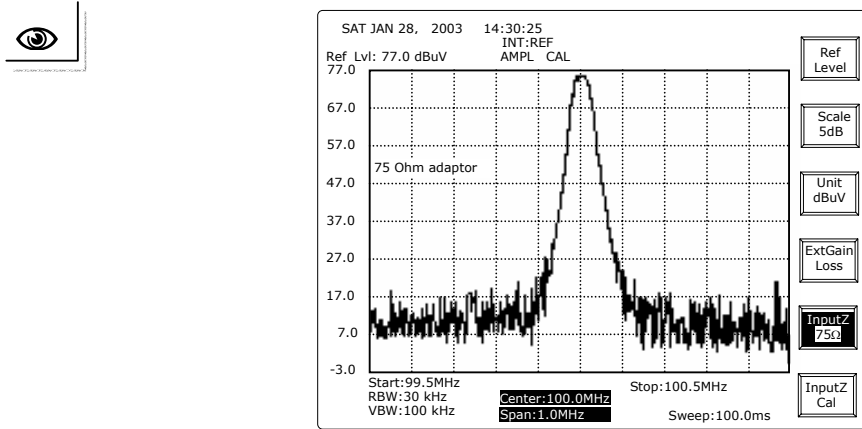
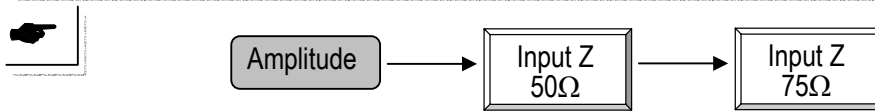

Keep pushing **Input Z** key will switch the input impedance between 50 and 75Ω. The prompted message will appear that the “zz adaptor” should be connected.

Input Z Cal

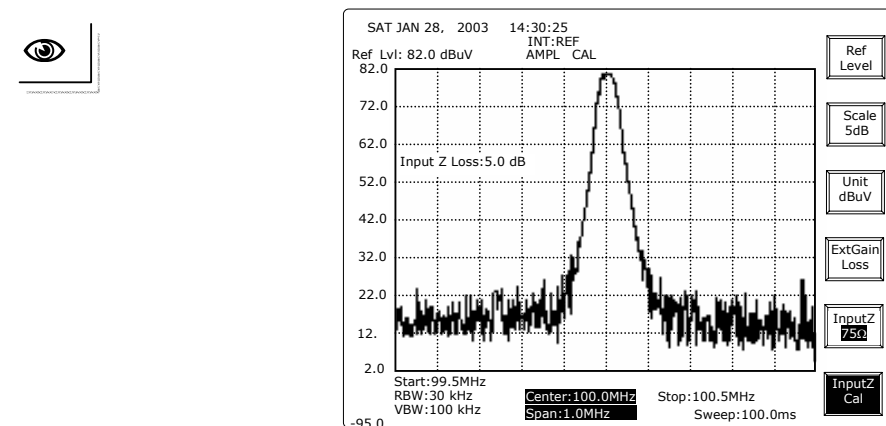
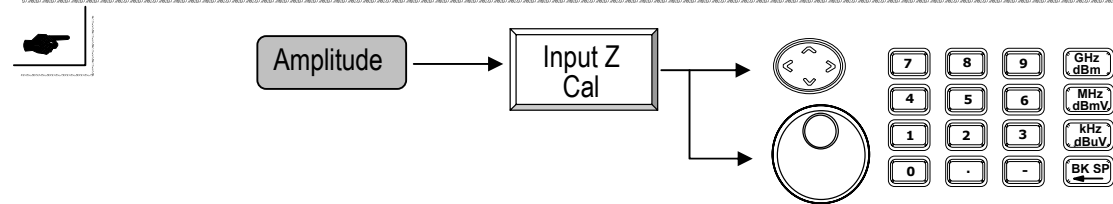

UP/DOWN and **Scroll**: To change offset by 0.1dB for every move.

Editing: Editing keys can adjust the offset from -10.0 to 10.0dB in 0.1 dB resolution. The ideal number is at 5.9dB

The “Input Z Cal” performs only when the input Z is at 75Ω. In other words, when the input Z is switched to 50Ω, the calibration value will return to 0.

8.2 Measurement Functions

8.2.1 Marker

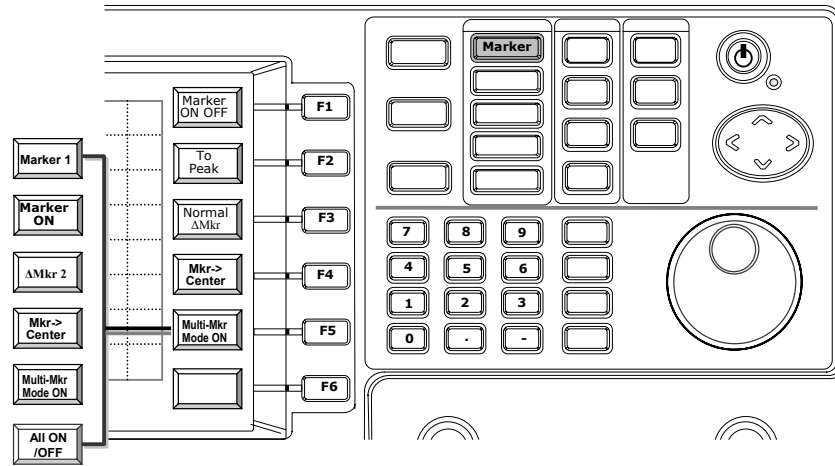

There are two operation modes of Markers due to Marker Number in operation. In single Marker mode, **Marker** is used to read the frequency and level readings of signal on the display.

This unit offers two modes of marker operation, single marker and multi-marker modes. In single marker mode, the **To Peak** function will let the marker find and stand on the peak signal. **Marker to Center** function will change the Center frequency to the marked frequency by marker. **Delta (Δ)** mode will activate the delta marker, which will present both the frequency and level differences with the reference marker.

The **Multi-Marker mode** can activate more markers up to ten. Under multi-marker mode, the measurement readings are displayed on the marker table. Every marker can be specified to be Δ Marker, and specify any other marker as its reference marker. **Markers to Peaks** function allows the markers to find the peak signals automatically. It is very useful to pick the EMI signals.

Marker ON/OFF

SAT JAN 28, 2003 14:30:25 Marker Level Freq(MHz)
 Ref Lvl: 77.0 dBuV INT:REF -83.6 100.0
 AMPL CAL

Marker ON/OFF

Normal ΔMkr

Mkr-> Center

Peak Search

MM mode Off

Start:99.5MHz Center:100.0MHz Stop:100.5MHz
 RBW:30 kHz Span:1.0MHz Sweep:100.0ms
 VBW:100 kHz

UP/DOWN and Scroll: To change marker frequency by 1/500 span for every movement.
Editing: To specify the marker frequency directly.

Note: The marker should be in the normal mode but not in the ΔMarker mode.

To Peak

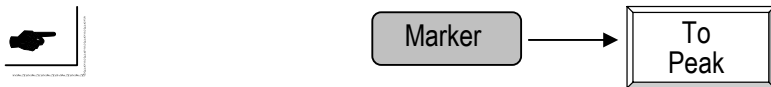

SAT JAN 28, 2003 14:30:25 Marker Level Freq(MHz)
 Ref Lvl: -30.0 dBm INT:REF -30.7 100.0
 AMPL CAL

Marker ON/OFF

Normal ΔMkr

Mkr-> Center

Peak Search

MM mode Off

Start:99.6MHz Center:100.1MHz Stop:100.6MHz
 RBW:30 kHz Span:1.0MHz Sweep:100.0ms
 VBW:100 kHz

The marker will find the Maximum signal on the display and present the level reading in the marker table which is on the upper-right corner of display.

Marker to Center

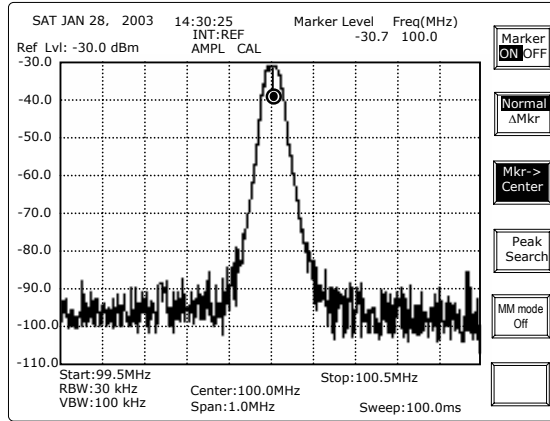
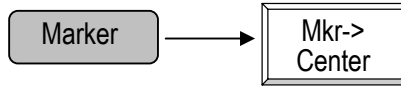

The Marker will find the maximum signal and present the amplitude reading in the marker table which is on the upper right corner of the display.

Delta Marker

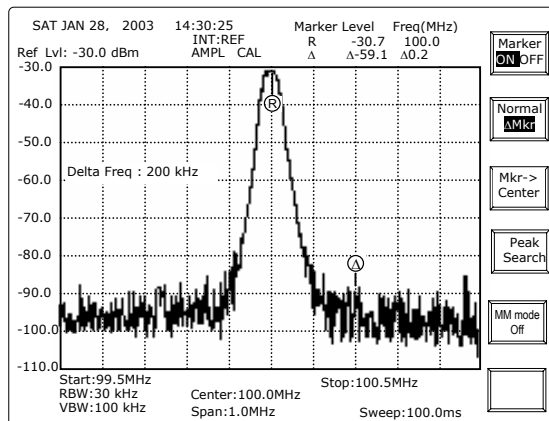
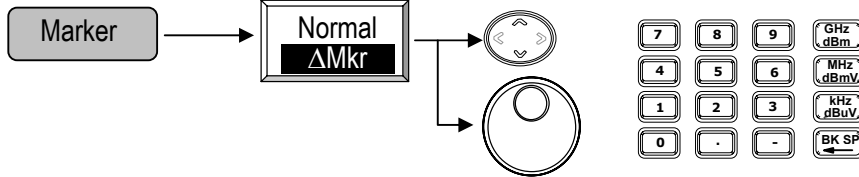

When operate with delta marker, enter the delta frequency rather than the absolute frequency.

Activate Multi Marker Mode, MM Mode

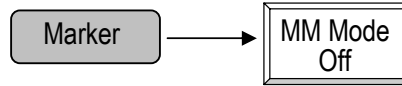

Switch the Multi-Marker Mode ON by pushing **MM Mode Off**, the related functions are as the following figure:

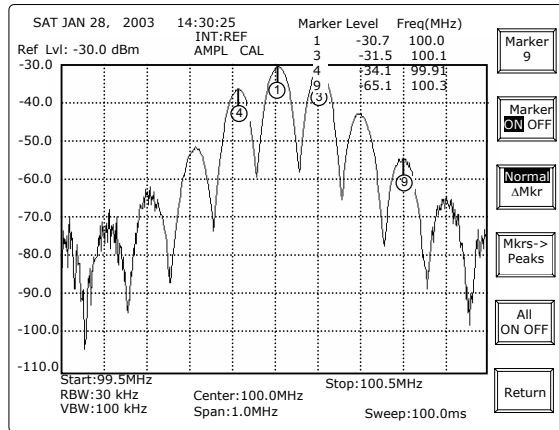

The steps for Multi-Marker Mode operation are as follows:

Normal mode:

Select Marker >> Turn ON marker >> Select Normal mode >> Enter the marker frequency

Delta mode,

Select Marker >> Turn ON marker >> Select Delta Mode >> Select the Reference Marker >> Enter the Delta Frequency

The operation details of each function key is described as follows:

Multi Marker Mode Operation—Normal Mode

Marker Selection

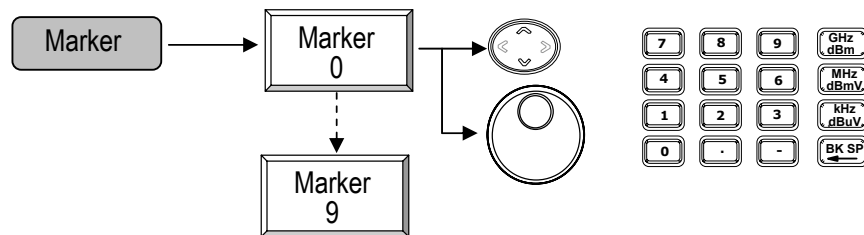

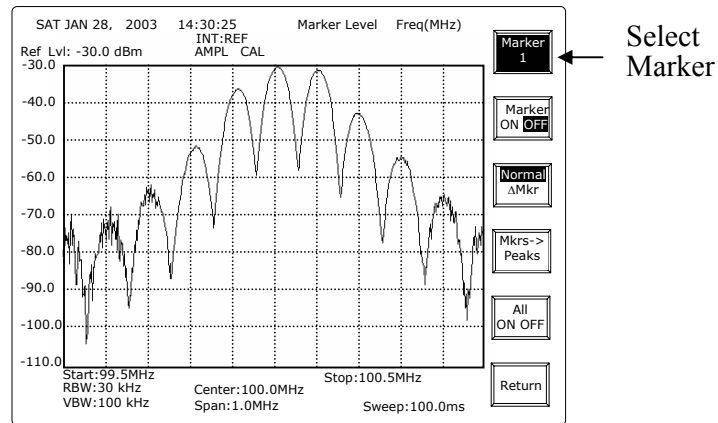

Marker m : Pushing this **Marker m** (m from 0 to 9) key can select the Marker number in the order from 0 to 9 and repeat from 0 after 9 is reached.

UP/DOWN and **Scroll**: To change the marker number in the order from 0 to 9.

Editing: To enter the marker number directly.

Turn Marker on and specify Marker frequency

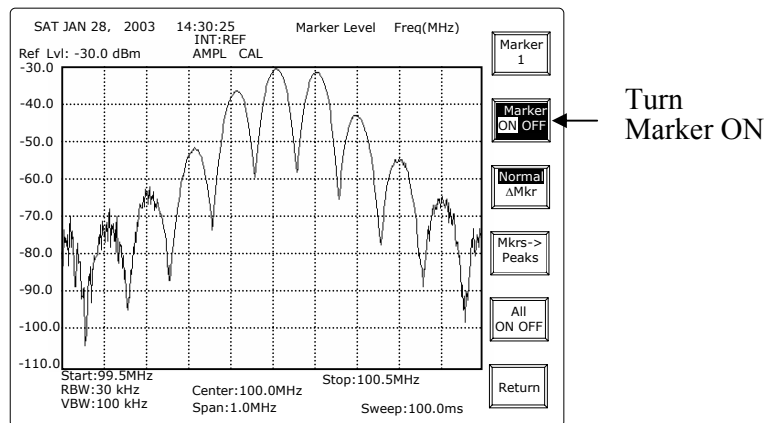

Enable the selected Marker ON to be ready for frequency entry first. Then specify the marker frequency.

No need to push **Marker** again when the unit is already in Marker functions.

Select Normal Mode and specify the Marker frequency

The diagram illustrates the steps to select Normal mode and specify the marker frequency. It shows a 'Marker' button leading to a 'Normal ΔMkr' button. To the right is a numeric keypad with units: GHz dBm, MHz dBmV, kHz dBuV, and BK SP. Below this is a screenshot of the spectrum analyzer interface. The screen displays a spectrum plot with a marker at 100.0 MHz. The control panel on the right includes buttons for 'Marker 1', 'Marker ON/OFF', 'Normal ΔMkr', 'Mkrs-> Peaks', 'All ON/OFF', and 'Return'. An arrow points to the 'Normal ΔMkr' button with the text 'Select Marker mode and specify Marker frequency'.

When the marker is in the normal mode, the characters “ Normal” is in the highlight situation.

No need to push Marker again when the unit is already in Marker functions.

Markers to Peaks

The diagram illustrates the process of switching from Marker to Markers to Peaks mode. It shows a 'Marker' button leading to a 'Markers to Peaks' button. Below this is a screenshot of the spectrum analyzer interface. The screen displays a spectrum plot with three markers. The control panel on the right includes buttons for 'Marker 3', 'Marker ON/OFF', 'Normal ΔMkr 1', 'Mkrs-> Peaks', 'ALL ON/OFF', and 'Return'. The 'Normal ΔMkr 1' button is highlighted.

Markers to Peaks will have all activated markers find the peak signals. Three activated markers will find the top 3 peak signals. If ten markers are all ON, the top 10 signals will be discovered.

All ON/OFF

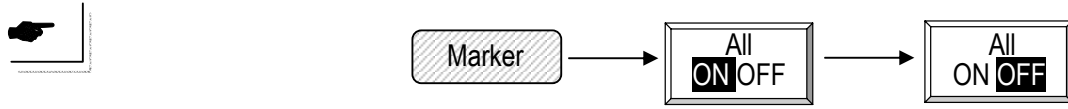

All ON/OFF is a quick key to turn ON/OFF all 10 markers.

Return



To exit the Multi-Marker mode.

Multi Marker Mode Operation—Delta Mode

Marker Selection

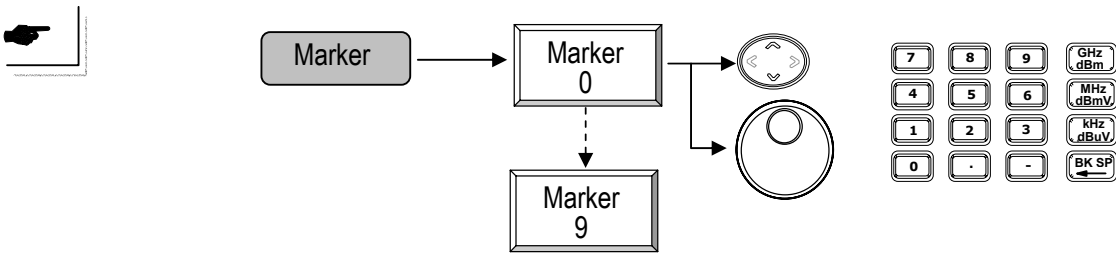

Marker d : Push this key (d: from 0 to 9) to select the **Delta Marker** number in the order of 0 to 9 and repeat from 0 after 9 is reached.

UP/DOWN and **Scroll**: To change the **Delta Marker** number in the order of 0 to 9.

Editing: To enter the **Delta Marker** number directly.

Turn Marker ON

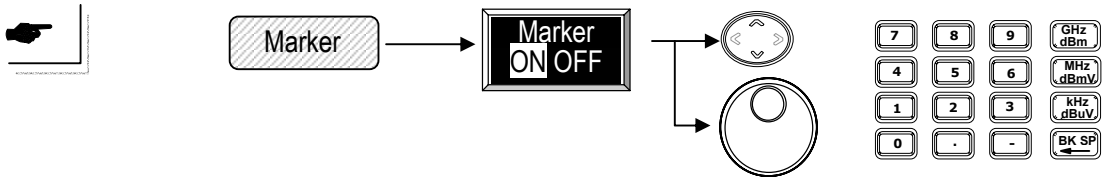

Select Delta Mode and specify the Reference Marker and delta frequency

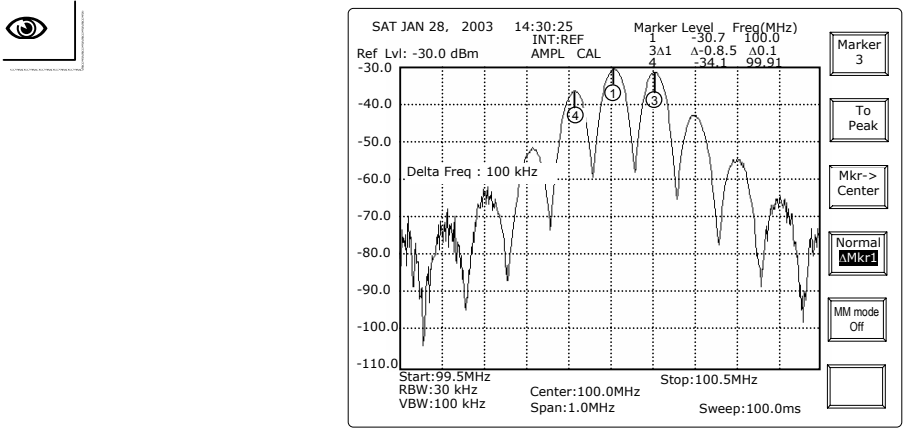
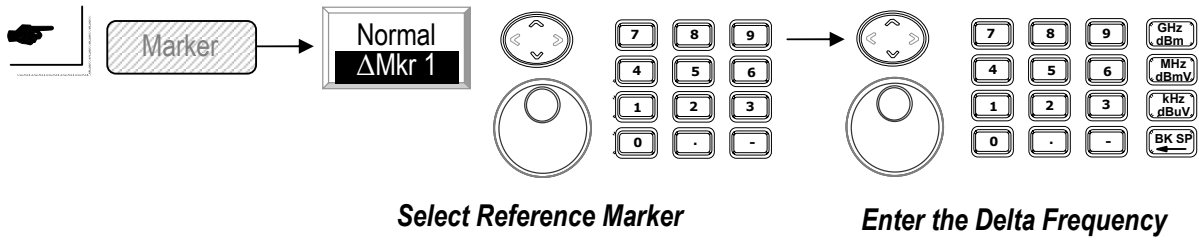

When the marker is in the delta mode, the characters “ ΔMkr ” is in highlight situation. Select Reference Marker first, then key in the delta frequency.

UP/DOWN and **Scroll**: To change the **Delta Marker** number in the order of 0 to 9

Editing: To enter the **Delta Marker** number directly.

Note: The Reference Marker and Delta Marker can not be the same one.

Markers to Peaks



Markers to Peaks will have all activated markers find the peak signals. Three activated markers will find the top 3 peak signals. If ten markers are all ON, the top 10 signals will be discovered. Please refer to the normal mode.

All ON/OFF



All ON OFF is a quick key to turn ON/OFF all selected markers. Please refer to the normal mode.

Return



To exit the Multi-Marker mode.

8.2.2 Peak Search

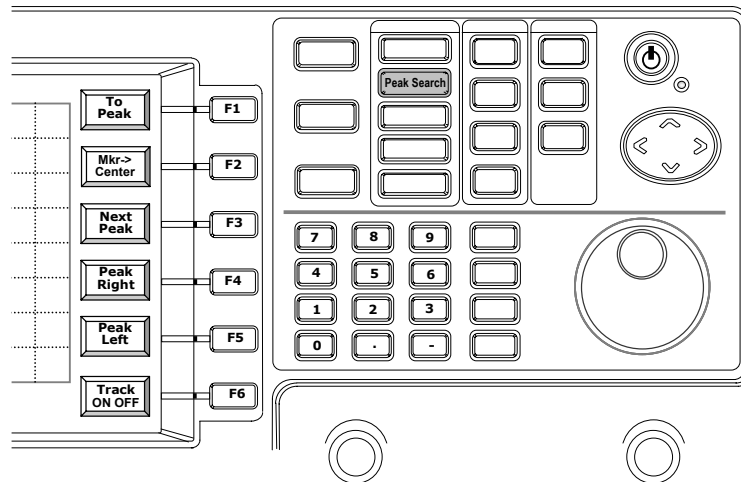

Peak Search is the functions to use marker to find the peak signals on the display. **Mkr->Center** function will let center frequency change to frequency of where the marker is standing.

Next Peak is to let marker find the next peak signal on display. **Peak Right** is to let marker rightward find the next peak signal; **Peak Left** let marker find the next peak signal leftward.

Track is to let marker continuously keep searching the peak signal and moving it to the center on the display.

To Peak

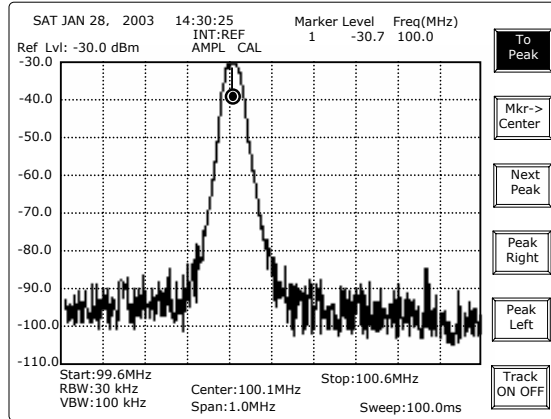
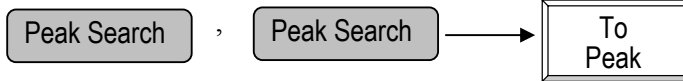

The marker will find the peak signal on the display. In MM Mode, the currently activated marker will find the peak.

Marker to Center

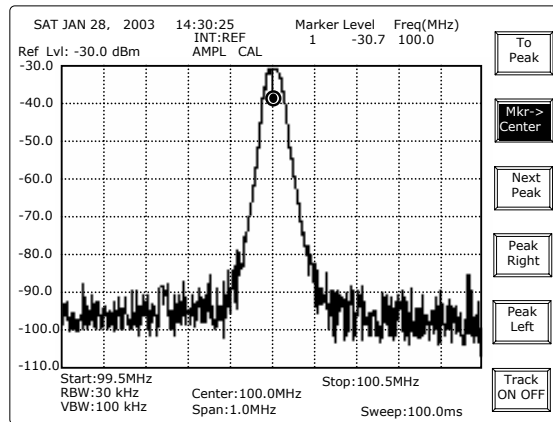
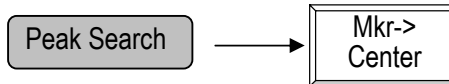

Note: The difference from **Peak to Center** in **Frequency** functions is that the Marker is activated in **Peak Search** group.

Next Peak

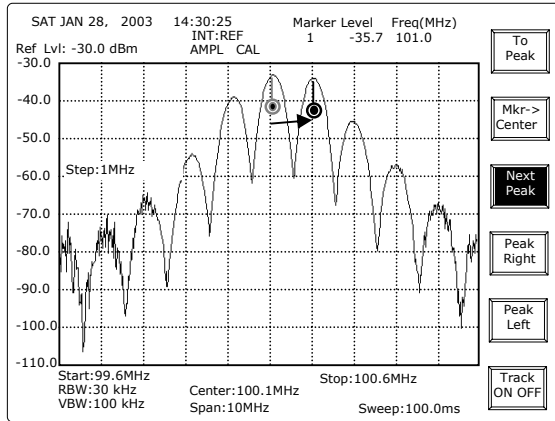
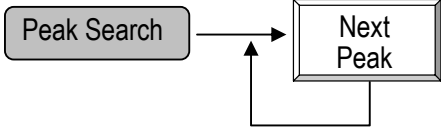

Next Peak will have the marker find the signal which level is next to current marker. Keep pushing the Next Peak will repeat the process as following figures.

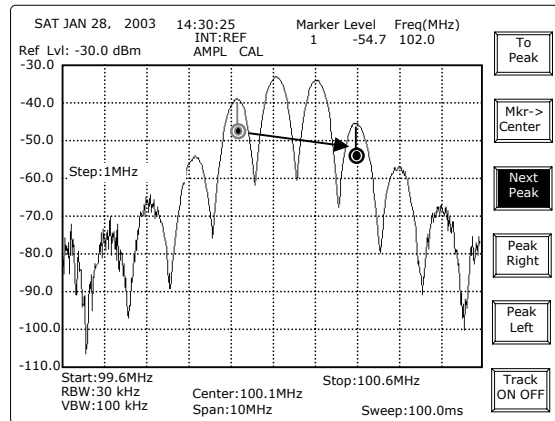
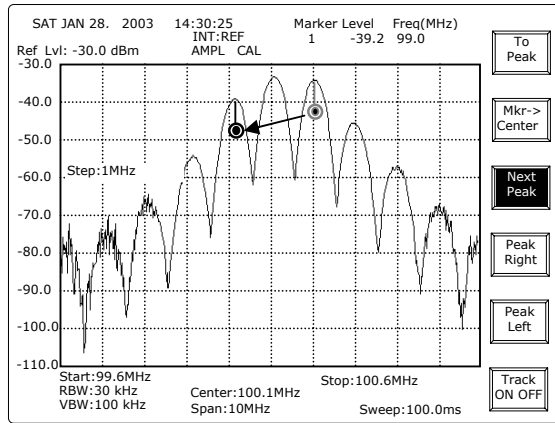

Peak Right

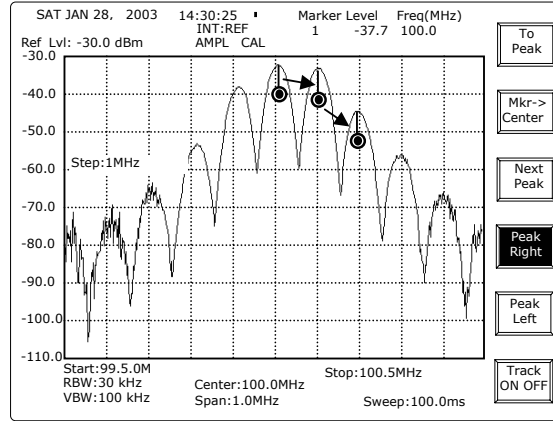
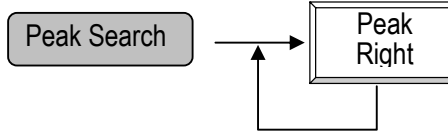

Repeat **Peak Right** key will have marker find the marker in the right side.

Peak Left

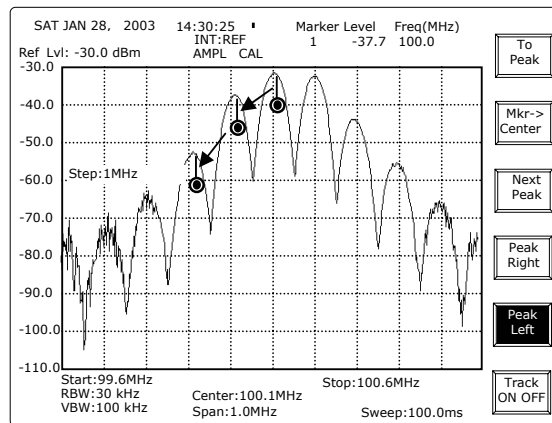
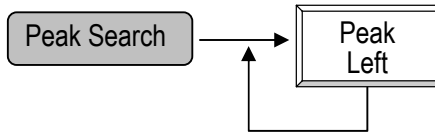

Repeat **Peak Left** key will have marker find the marker in the left side.

Track ON

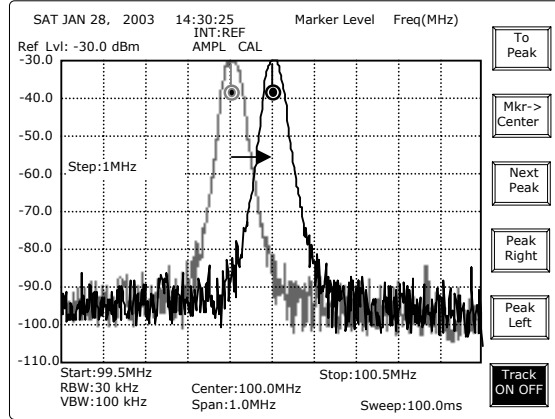
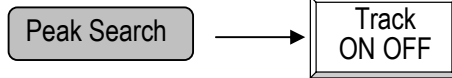

Track function will dynamically track the Peak signal and move the signal to the center. In fact, it equal to the combination of **Peak Search** + **Marker to Center** which is performed all the time.

Note: Because the marker continuously keeps searching the peak signal and moving it to the center on the display, therefore the Center Frequency is changeable as long as the track function is on.

8.2.3 Trace

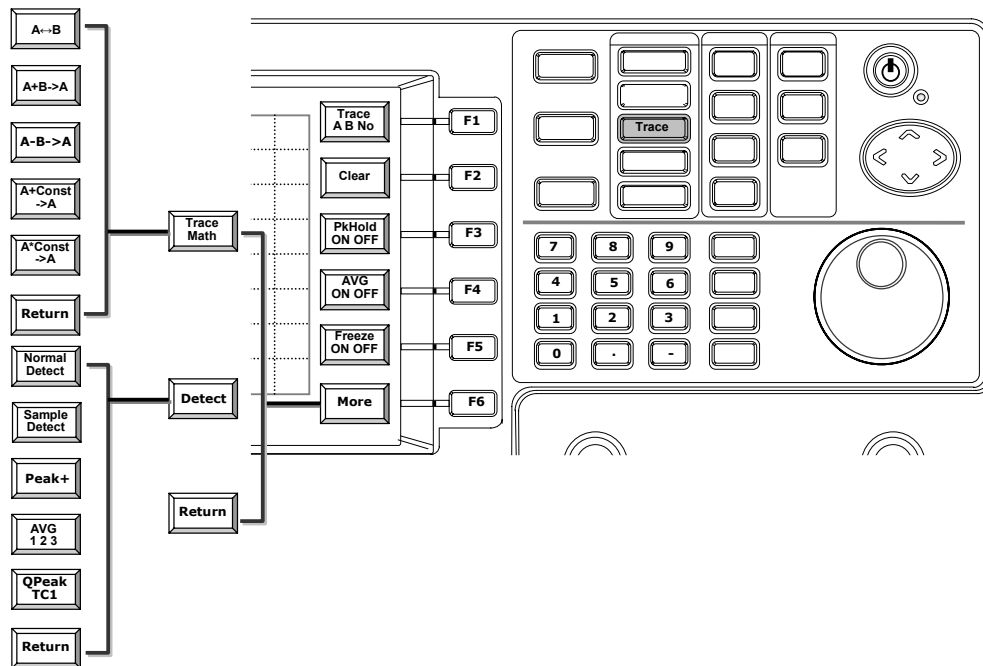

There are three traces **Live**, **Tr. A** and **Tr. B**. Live trace is always the one measuring the signal. Trace A and Trace B are the traces for memory access. The Clear function is to clear the Trace A and Trace B.

Live Trace has **Peak Hold**, **Average** and **Freeze** functions. Peak hold function is to hold the peak signal until the next higher level signal is appeared. When the next higher signal is coming, it will update the signal. Average function will average the specific number of traces and present the result of average on the display. Freeze function will stop sweeping and present the last trace.

The **Trace Math** directly uses the trace data to perform the math operation. In other words, when trace A plus trace B in dB, the result is dB number pulsing other than transferring into linear scale.

There are also several detection modes are provided. Basically the data of every point is taken from several samples. How many samples are taken for one data will depend on the setting of **RBW** and **SPAN**. There are several ways to pick one to present the all taken samples. **Normal** mode takes average, **Sample** mode will pick randomly, and **Peak +** mode will pick the maximum one. It is so-called positive peak sometimes.

There are also two detection modes implemented by hardware. **Average** is done by low pass filter. There are three time constants of **Quasi Peak** detection, TC1, TC2 and TC3 for 600ms, 550ms and 160ms respectively.

Trace Selection

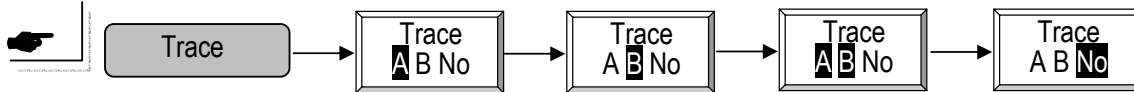

Repeat this key to select trace A, B, both or none.

Clear Trace Data



Push this key to clear data of selected trace.

Peak Hold



Push this key to perform the Peak Hold function.

Average Trace

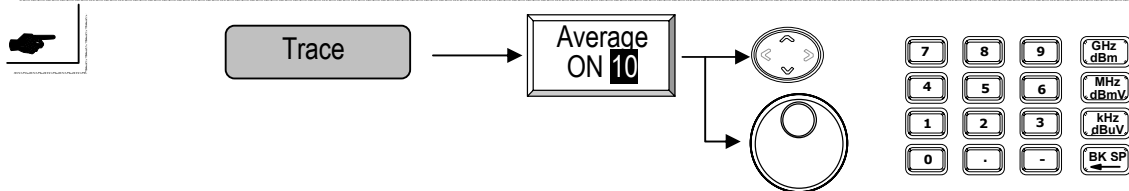

Push this key and set the number to perform the average function. It is implemented by the software.

Freeze



Pushing this key can freeze the trace on the display.

Trace Math Operation

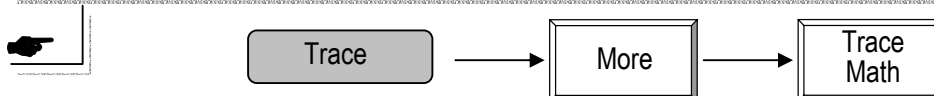

Pushing this key will start the trace math operation.

Exchange A and B

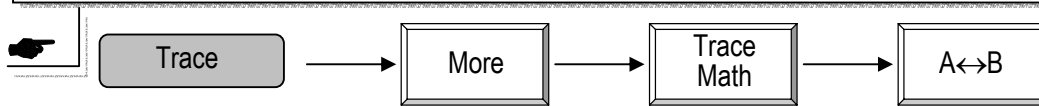

Move A+B into A

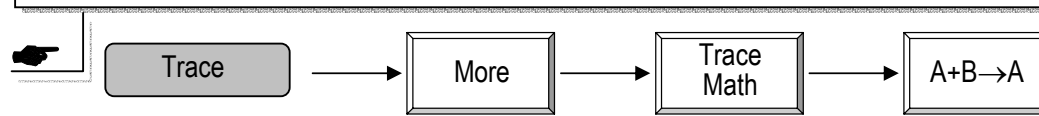

Move A-B into A

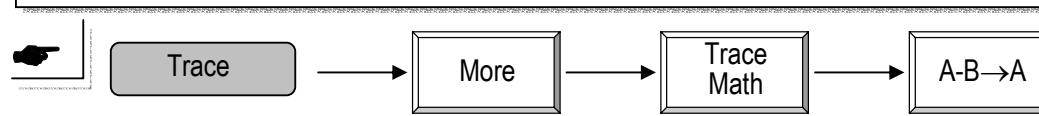

Move A + Constant into A

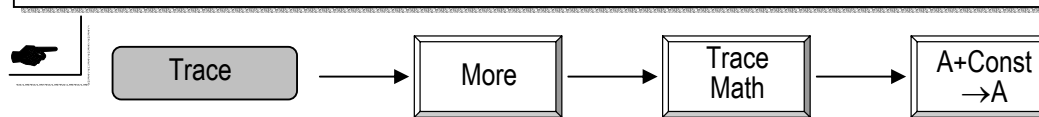

Move A - Constant into A

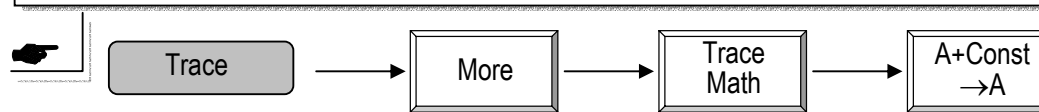

Detection Mode

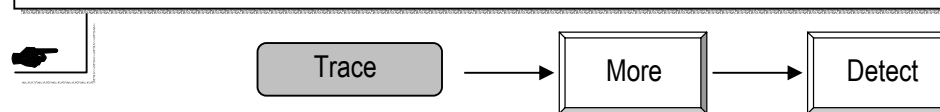

Access this key can operate the following detection modes.

Normal Detection

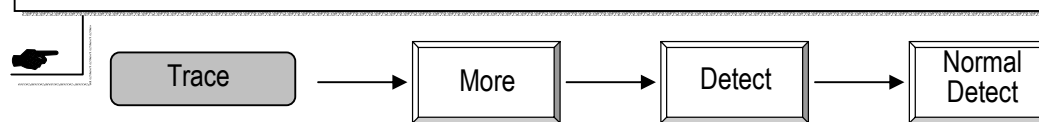

Sample Detection Mode

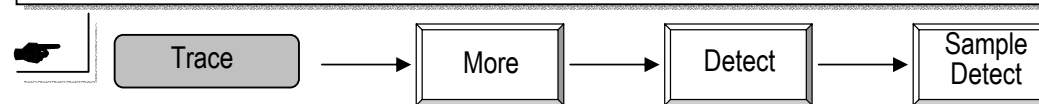

Positive Peak Detection Mode

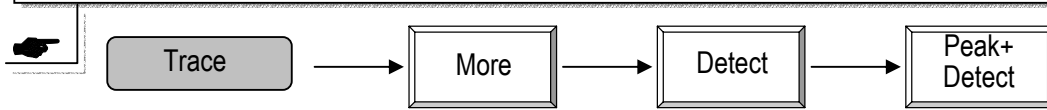

Average Detection Mode

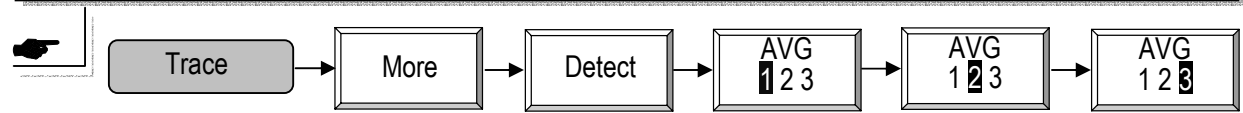

Quasi Peak Detection Mode

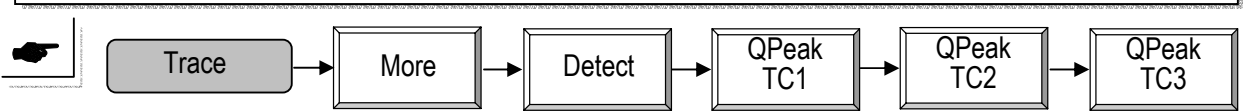

8.2.4 Pwr Measurement

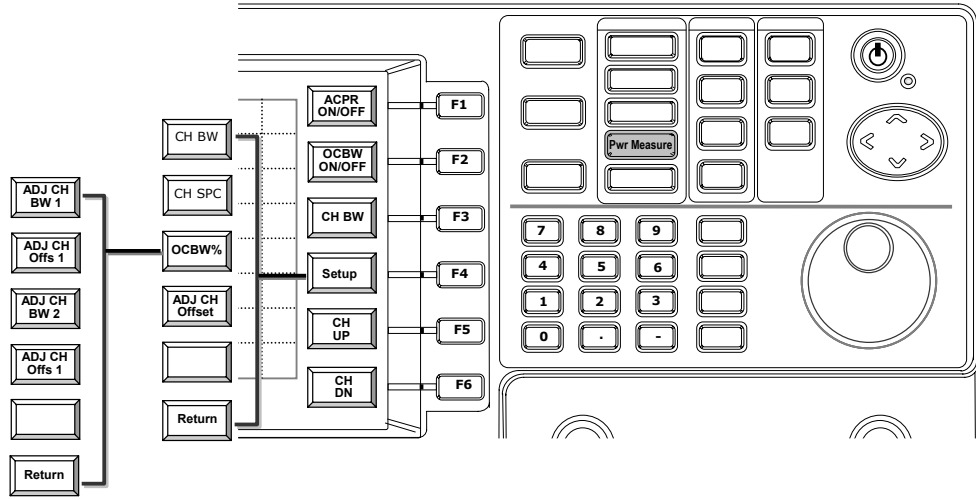

Power measurement functions provide the **ACPR** (Adjacent Channel Power Ratio), **OCBW** (OCcupied BandWidth). For **ACPR** measurement, the **CH BW** (channel bandwidth), **Adj CH SPC** (adjacent channel bandwidth) and **Adj CH Offs** (adjacent channel offset) have to be specified first. The ACPR measurement turns out the power ratio of main channel and upper/lower adjacent channels in dB. The terminology ACLR (Adjacent Channel Leakage Ratio) is sometimes used instead.

Adj CH BW and **Adj CH Offs** are defined in **ADJ CH OFFSET** functions. Two types of **ACPR** with different channel BW and offset can be measured simultaneously. They are noted as **Adj CH 1 (LACPR 1/ UACPR1)** and **Adj CH 2 (LACPR 2/ UACPR 2)** in the P0wer measurement table.

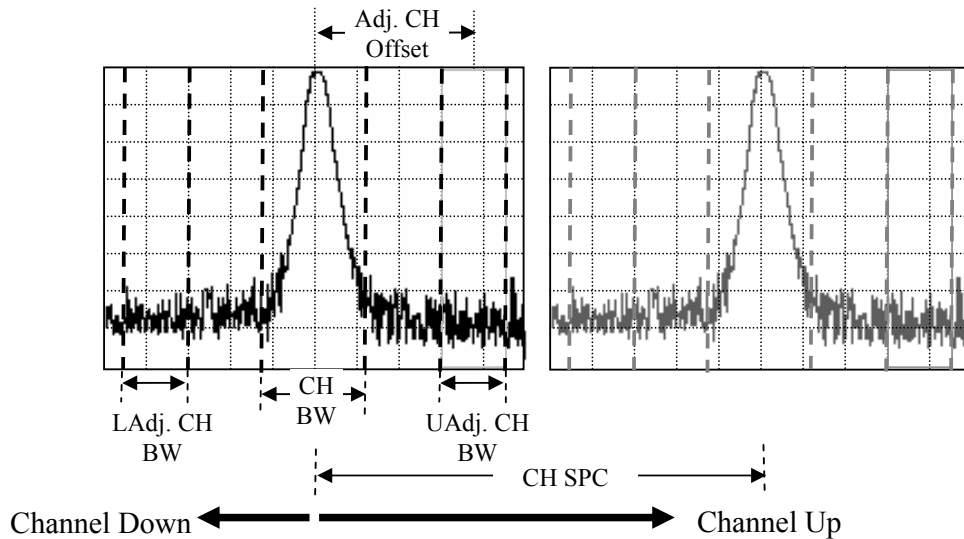

Definitions for ACPR measurement

For **OCBW** measurement, **CH BW** and **OCBW %** (percentage) need to be specified first. The OCBW will measure the bandwidth that occupies the power percentage.

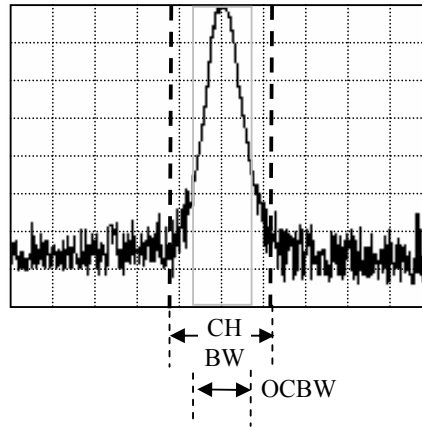

Definitions for OCBW measurement

All CH BW, CH SPC and OCBW % are defined in **Setup** function. When the channel parameters are set, by defining **CH SPC** (channel Spacing) it is easy to measure the next channels by **CH UP** and **CH Dn** keys.

Steps for ACPR Measurement are as follows.

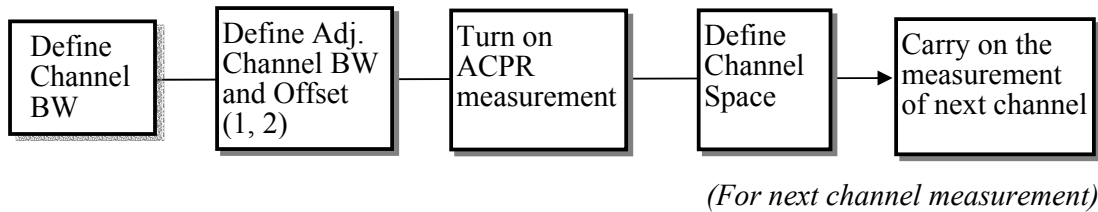

Steps for OCBW Measurement are as follows.

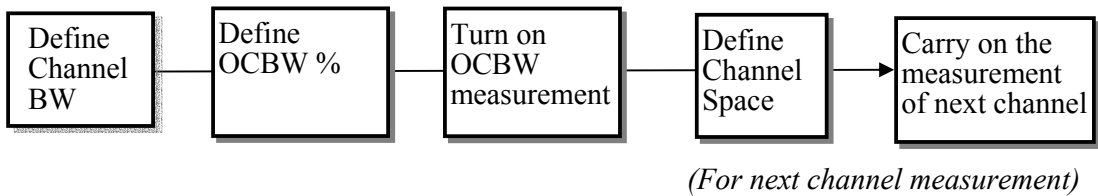

For the detailed information of each operation, please refer to the following paragraphs.

ACPR Measurement

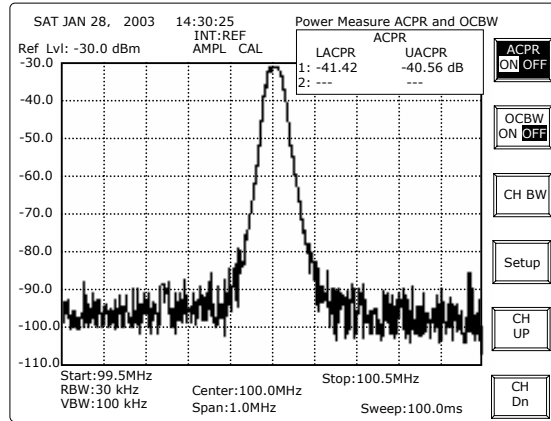
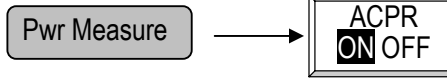

Note: When Adj CH BW 2 and Adj CH Offs 2 are also set, the ACPR 2 will present the measurement results.

OCBW Measurement

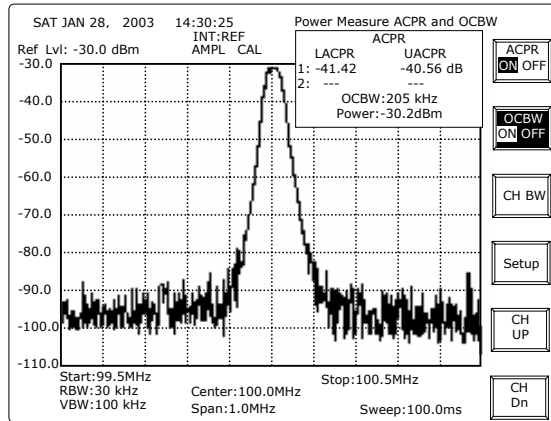
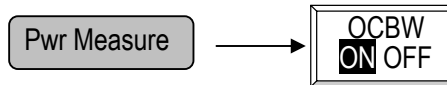

CH BW

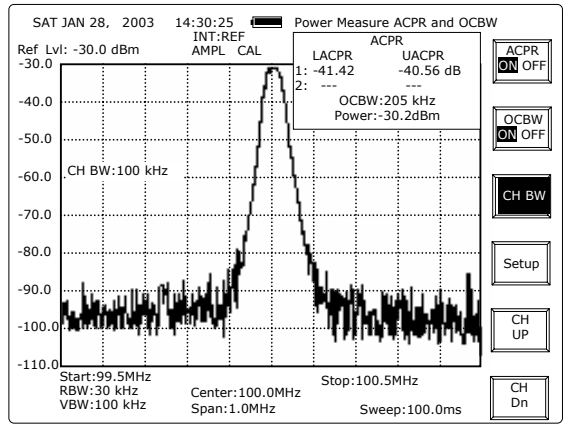
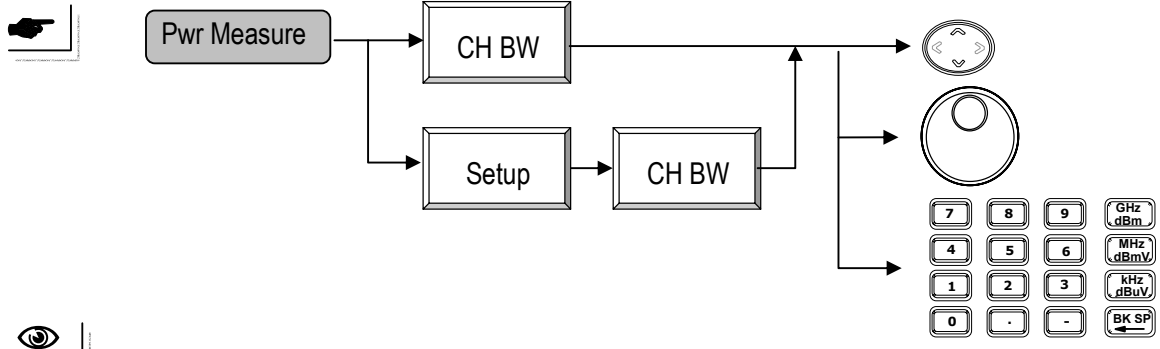

UP/DOWN and **Scroll**: To change the frequency by 0.1kHz for every adjustment.
Editing: Editing keys can adjust the channel bandwidth directly.

Channel Setup

Channel Setup is to define the channel parameters that include **Channel Bandwidth**, **Channel Space**, **OCBW Percentage** and **Adjacent Channel Offset**.

Channel Bandwidth

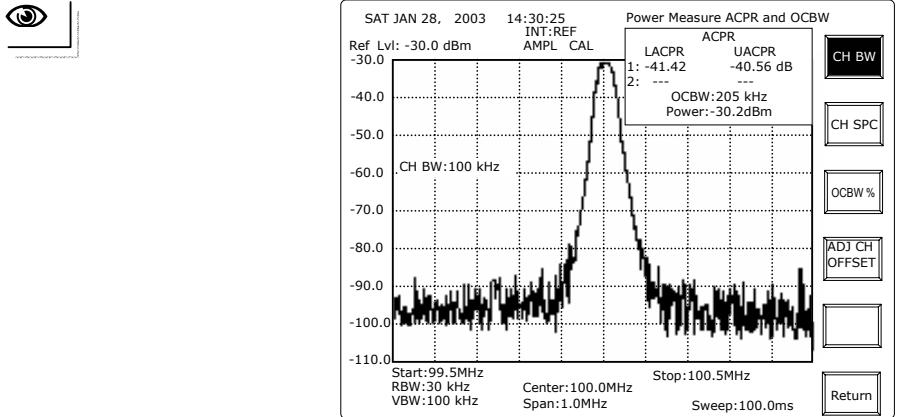
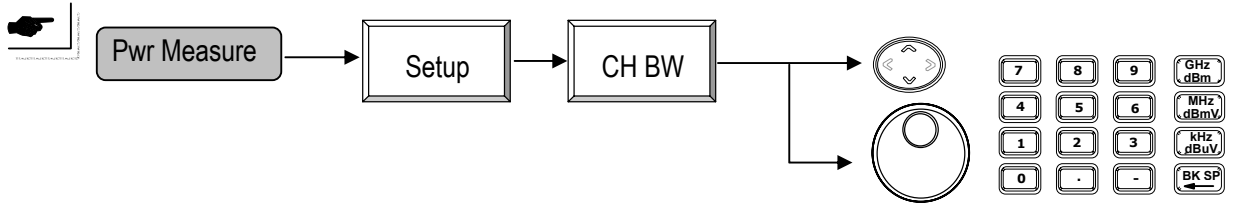

UP/DOWN and **Scroll**: To change the frequency by 0.1kHz for every adjustment.

Editing: To adjust the channel bandwidth directly.

Channel Spacing

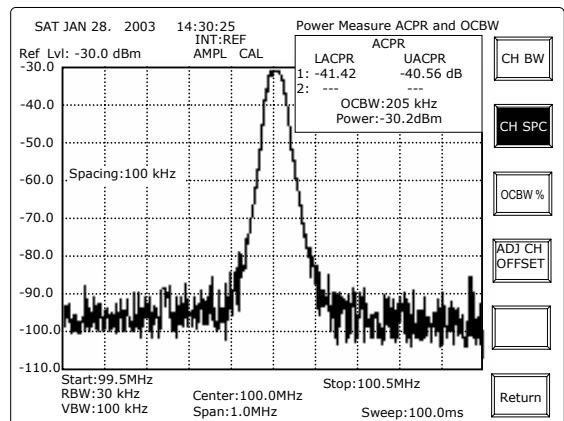
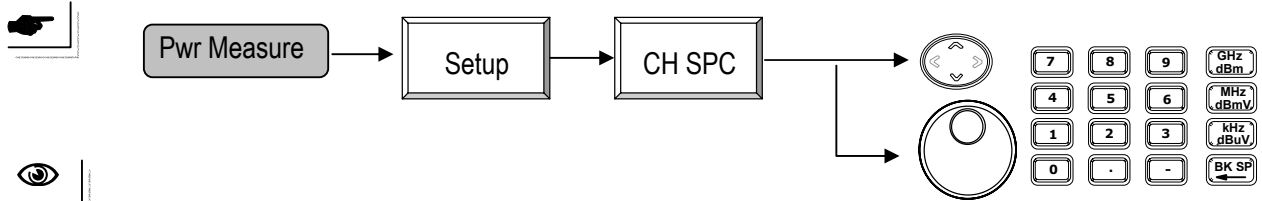

UP/DOWN and **Scroll**: To change the frequency by 100kHz for every adjustment.

Editing: To adjust the channel bandwidth directly.

OCBW %

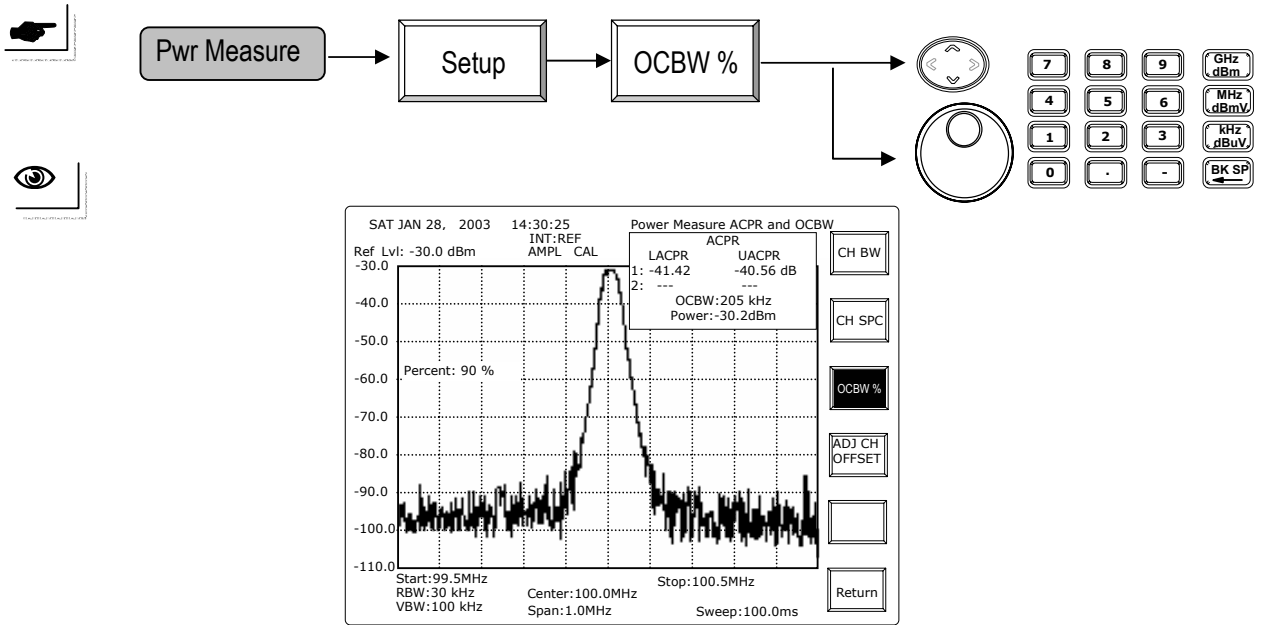

UP/DOWN and **Scroll**: To change the power ratio by 1 percent for every adjustment.

Editing: Numerical keys followed by Enter key can set from 0 to 100 % directly.

Adjacent Channel Offset

Adjacent Channel Bandwidth 1(2)

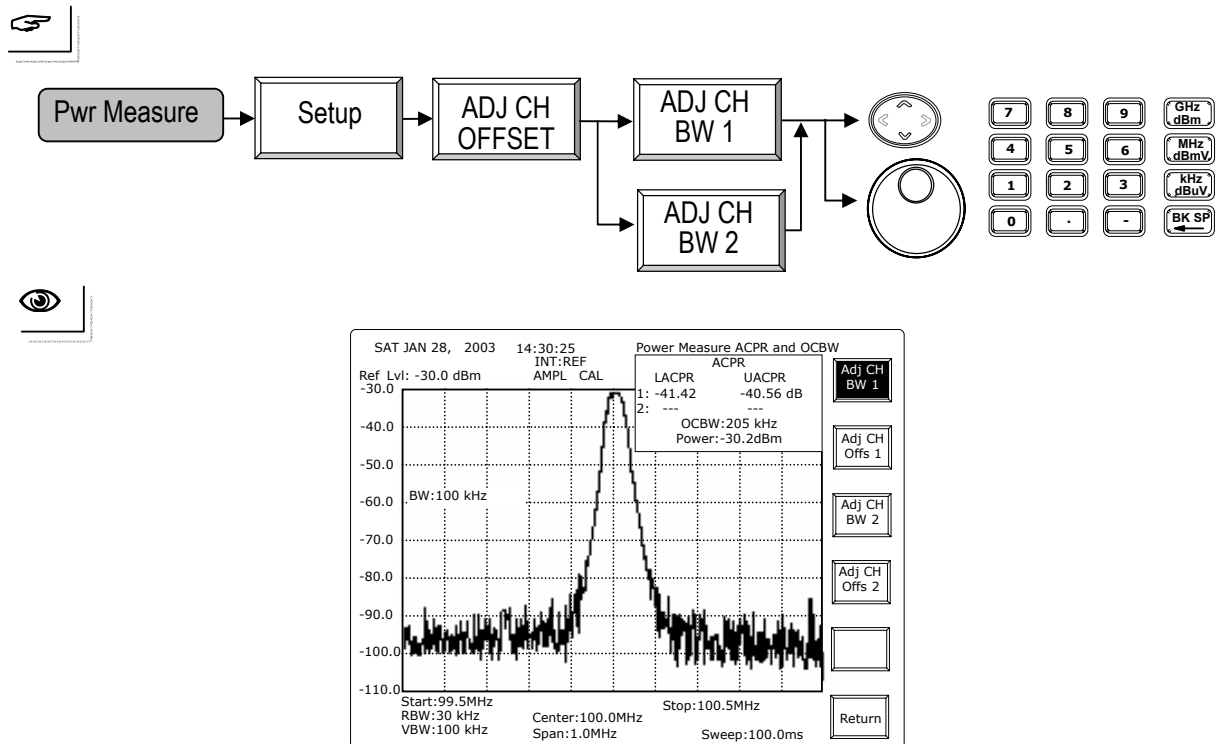

Adjacent Channel Offset 1(2)

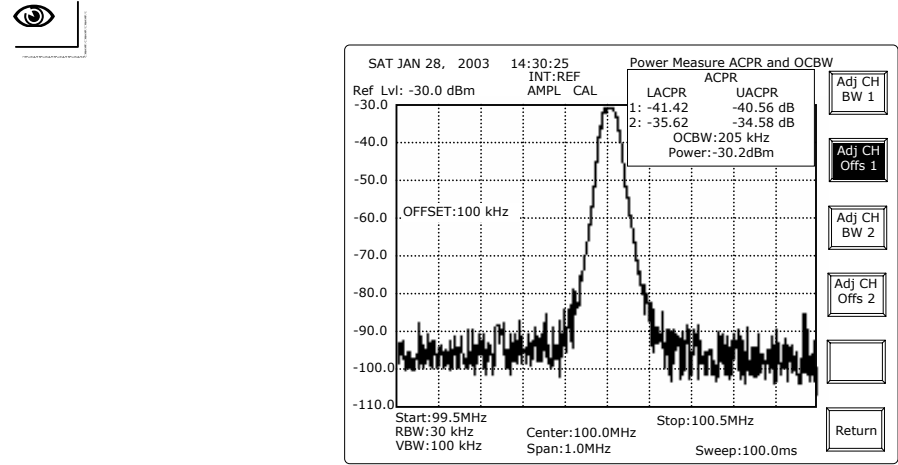
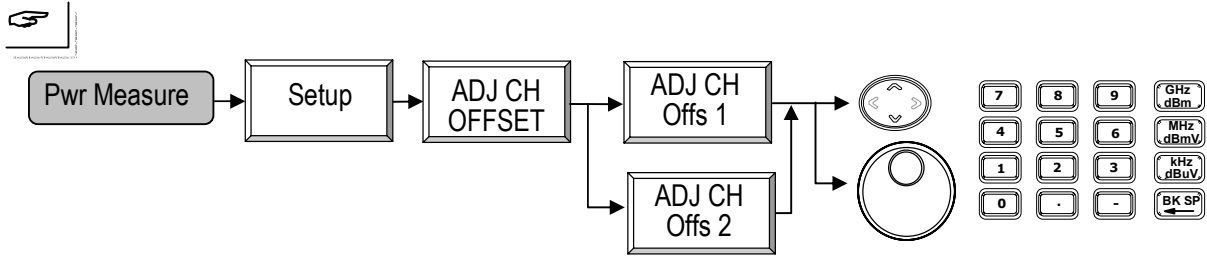

Channel UP

The Power Measurement will measure the next higher channel.

Channel Down

The Power Measurement will measure the lower channel.

8.2.5 Limit Line

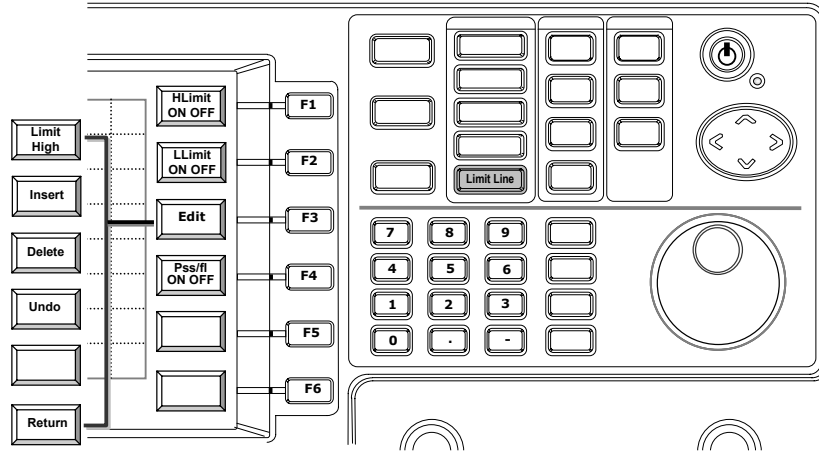

Limit Line functions provide two limit lines, **High Limit** and **Low Limit** to perform the **Pass/Fail test**. The Limit lines are easy to edit to fit the required threshold.

Limit Line ON/OFF

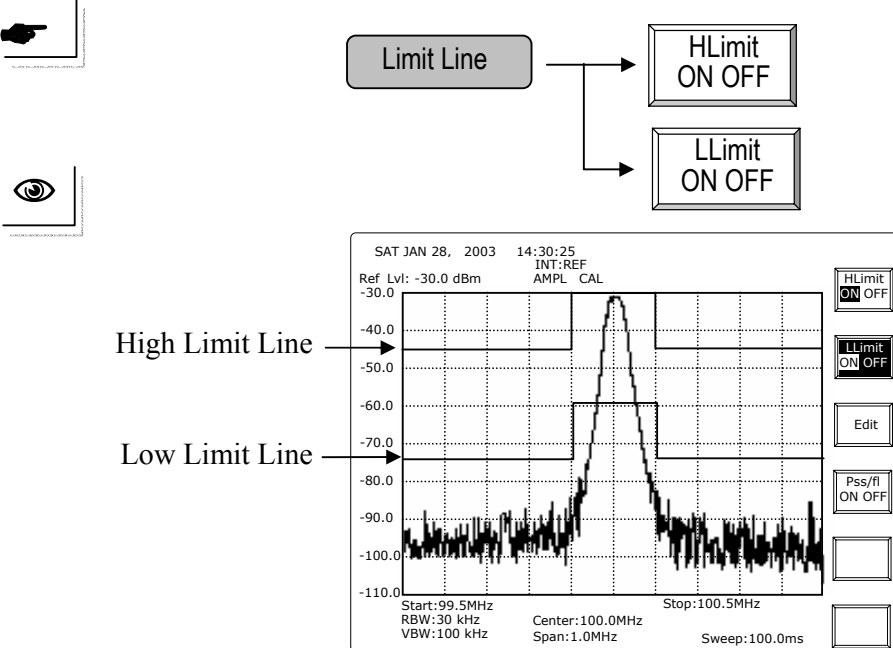

Edit

The Limit Line is edited by mean of defining point by point. Each time a new point is inserted in the table, the Limit Line is connected to the ahead and followed points immediately. More details are described in the following paragraphs.

High Limit /Low Limit Selection

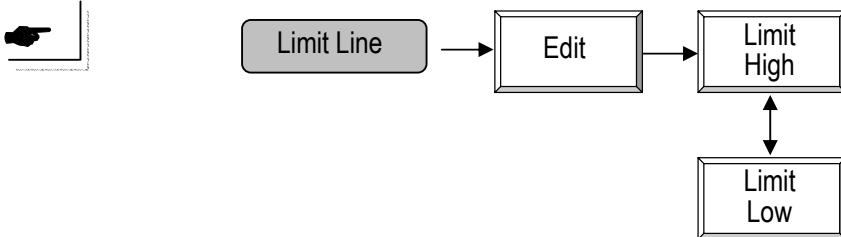

Repeating **F1** will toggle high limit and low limit to edit.

Limit Line Edit

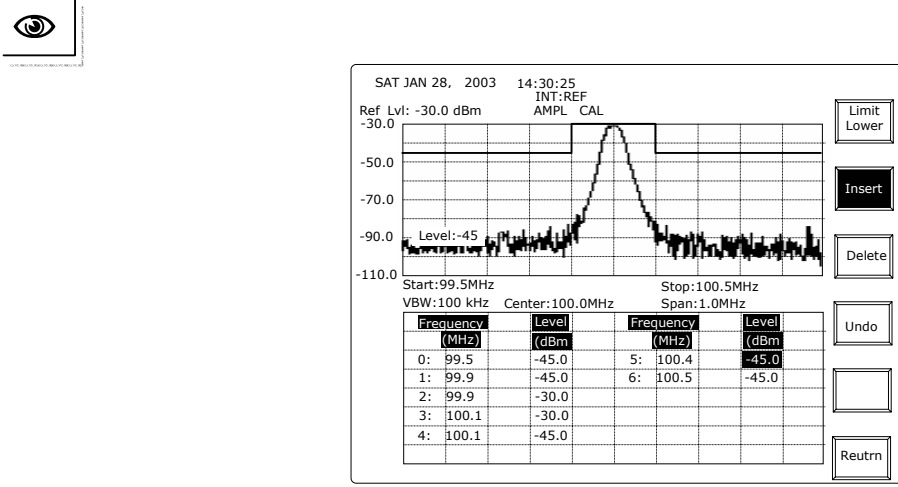
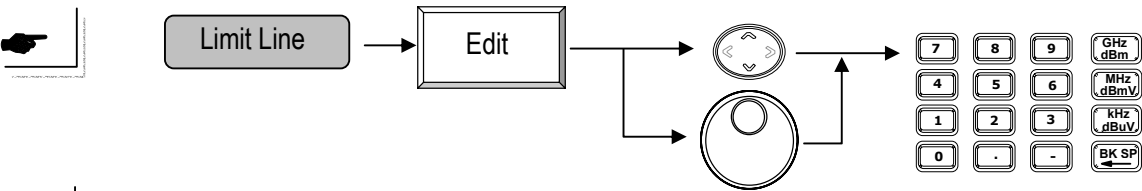

UP/DOWN and Scroll: To move the cursor to the field to edit.

| | | | | | | |
|---|-------|-------|---|---|-------|-------|
| 0 | 99.5 | -45.0 | ↑ | 5 | 100.4 | -45.0 |
| 1 | 99.9 | ← | → | 6 | 100.5 | -45.0 |
| 2 | 99.9 | -30.0 | ↓ | | | |
| 3 | 100.1 | -30.0 | | | | |
| 4 | 100.1 | -45.0 | | | | |

Editing: Enter the frequency (horizontal) or level(vertical) of the point.

Insert a point



| | | | | | | |
|---|-------|-------|--|---|-------|-------|
| 0 | 99.5 | -45.0 | | 5 | 100.1 | -45.0 |
| 1 | | -45.0 | | 6 | 100.4 | -45.0 |
| 2 | 99.9 | -45.0 | | 7 | 100.5 | -45.0 |
| 3 | 99.9 | -30.0 | | | | |
| 4 | 100.1 | -30.0 | | | | |

When a new point is inserted at its current field, the temporary values of frequency and level are automatically generated. Both new values are the average of ahead and followed points.

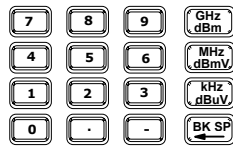

Enter the desired frequency. Take 100.3MHz as example here.

| | | | | | | |
|---|-------|-------|--|---|-------|-------|
| 0 | 99.5 | -45.0 | | 5 | 100.1 | -45.0 |
| 1 | | -45.0 | | 6 | 100.4 | -45.0 |
| 2 | 99.9 | -45.0 | | 7 | 100.5 | -45.0 |
| 3 | 99.9 | -30.0 | | | | |
| 4 | 100.1 | -30.0 | | | | |

When the entry is completed, the table will sort itself immediately by the order of frequency. The limit line is modified accordingly. Enter the Level value if it is necessary.

| | | | | | | |
|---|-------|-------|--|---|-------|-------|
| 0 | 99.5 | -45.0 | | 5 | 100.3 | |
| 1 | 99.9 | -45.0 | | 6 | 100.4 | -45.0 |
| 2 | 99.9 | -30.0 | | 7 | 100.5 | -45.0 |
| 3 | 100.1 | -30.0 | | | | |
| 4 | 100.1 | -45.0 | | | | |

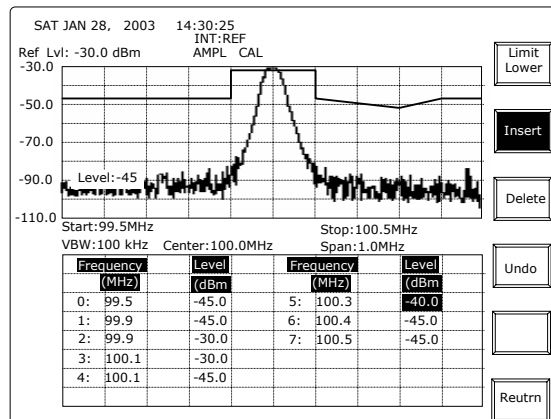

Delete a Point

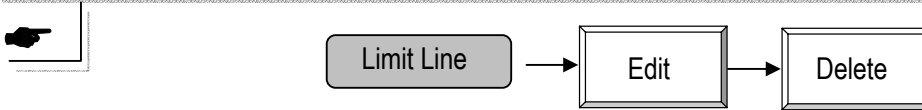

Delete point will remove the point where the cursor is located.

Undo

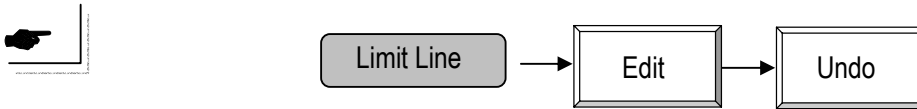

Undo function will recover the previous editing, it can be either Insert or Delete. Only one step is reserved.

Pass/ Fail test

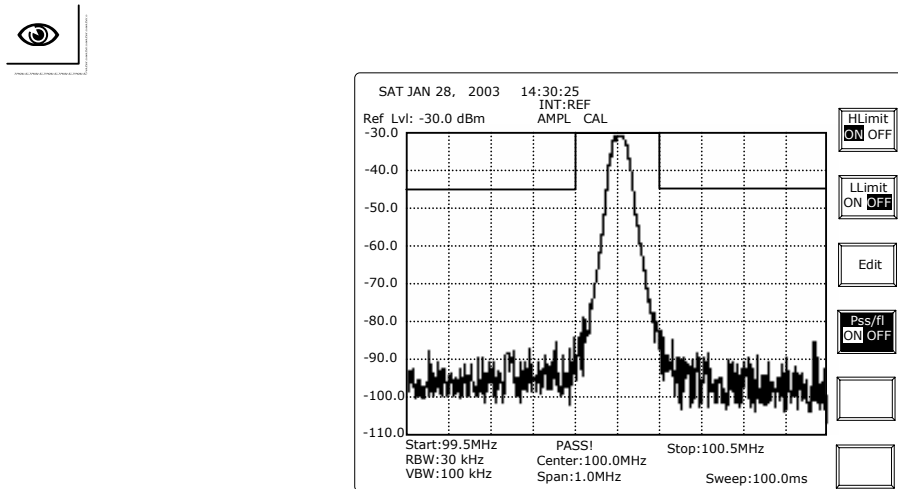

8.3 Control Functions

8.3.1 BW

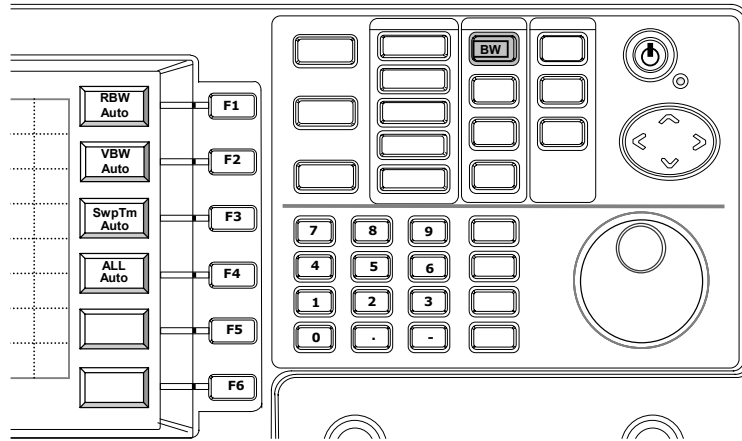

BW functions include **RBW**, **VBW** and **Sweep Time**. All of the functions have **AUTO** and **Manual** mode. In **ALL Auto** mode, these parameters are coupled with **Span**. Which means different **Span** selection will choose its adaptive **BW** combination. Every parameter in **BW** can be set **Manual** mode separately.

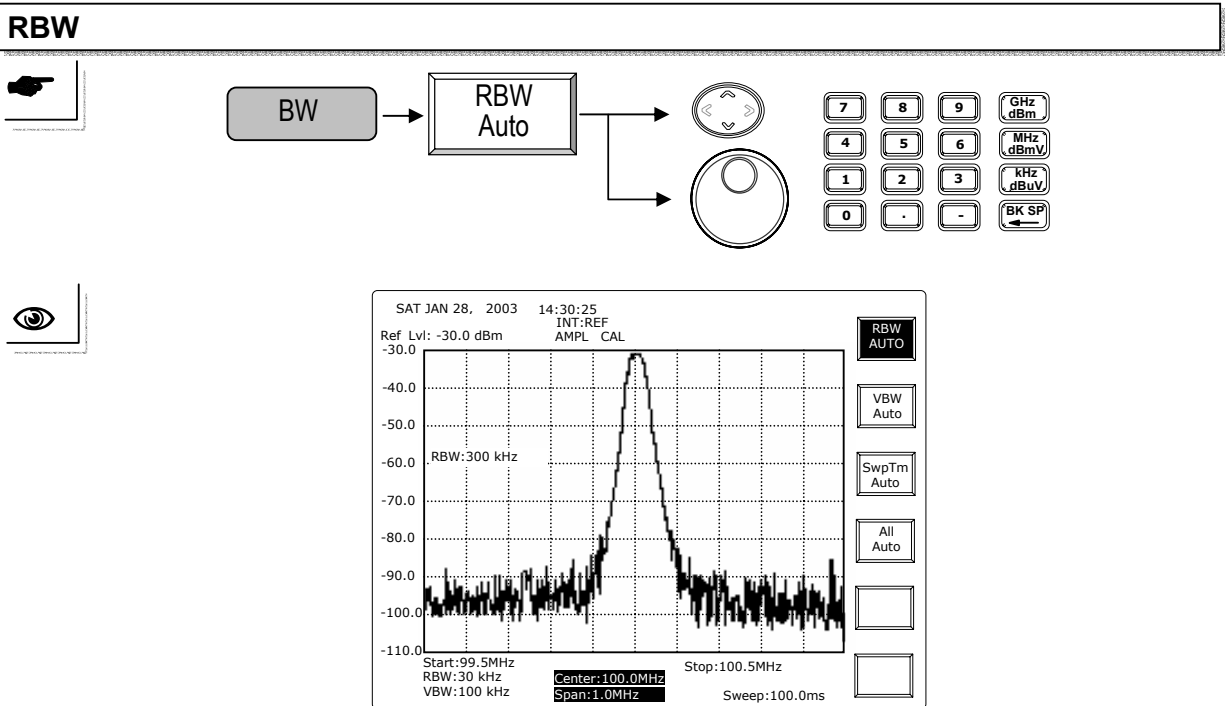

Repeating **RBW Auto** key can switch the RBW between Auto and Manual mode.
UP/DOWN and **Scroll**: Select the RBW within 3k, 30k, 300k and 4MHz under Manu Mode.
Editing: The editing entry will select the closest RBW to 3k, 30k, 300k and 4MHz.

VBW

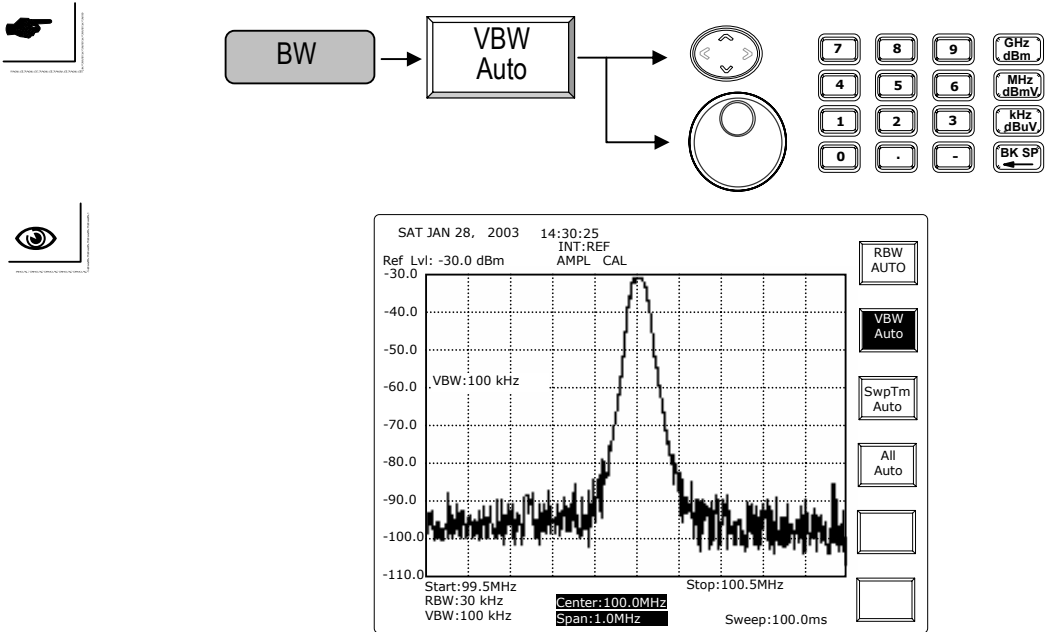

Repeating **VBW Auto** key can switch the **VBW** between **Auto** and **Manual** mode.

UP/DOWN and **Scroll**: Select the RBW within 10Hz to 1MHz in 1-3 sequence in Manu Mode.

Editing: The editing entry will select the closest VBW as described above.

Sweep Time

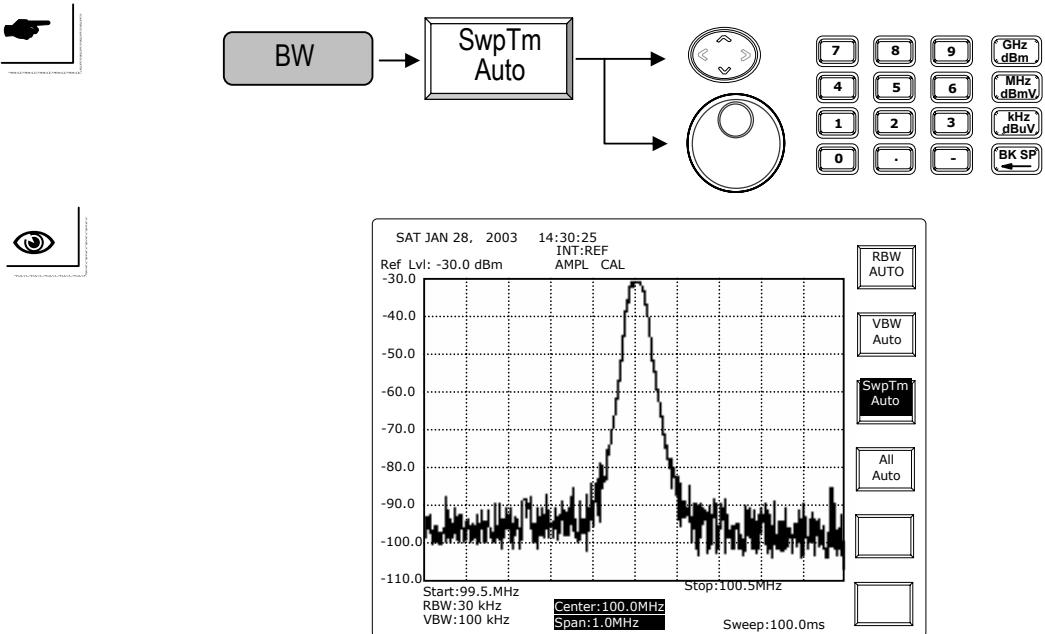

Repeating **SwpTm Auto** key can switch the **Sweep Time** between **Auto** and **Manual** mode.

UP/DOWN and **Scroll**: Change the Sweep Time to Manu Mode.

Editing: Enter the sweep time directly. The minimum is 100msec.

8.3.2 Trigger

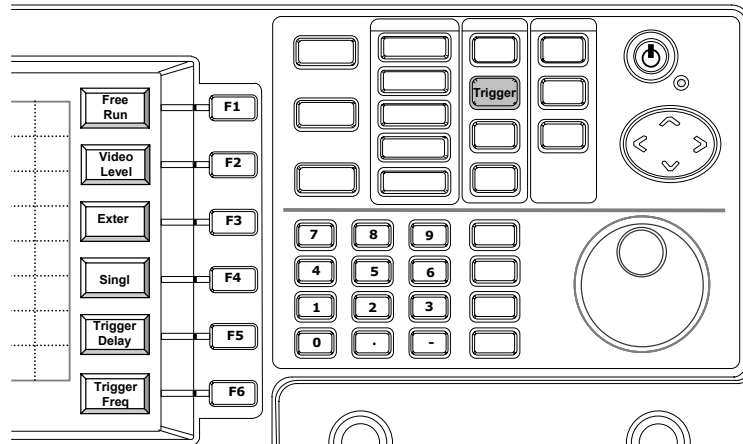

Trigger is the feature that the measurement starts when the trigger condition is met. In other words, even in the trigger mode, the measurement sweep will not start until the trigger condition is match. There are two trigger modes, **Single** and **Continuous**. As long as the trigger condition is met, the **Single** mode only performs one measurement sweep while the **Continuous** mode performs the sweep continuously. Before the trigger condition is met, the sweep will not work.

There are two sources of trigger condition, **Video Level** and **External** trigger from rear panel. Video Level means the level of display. The input signal has to reach the video level to trigger the measurement sweep. The default of trigger frequency is **Center Frequency**. It can be changed with **Trigger Freq** setting.

Another source of trigger is from **External Input** on the rear panel. A 0 to 5V rising edge will trigger the sweep in external trigger mode.

Trigger delay allows sweep happens later than the condition is match.

Activate **Free Run** to stop trigger function.

Free Run



Free Run will stop trigger function and stay in normal sweep mode.

Video Level

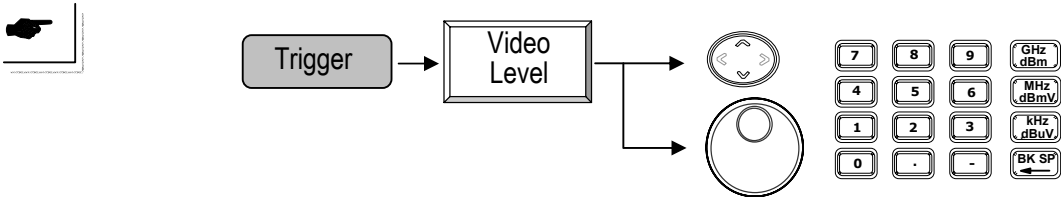

UP/DOWN and **Scroll**: To change the video level by 0.1dBm for every movement.

Editing: To enter the level on display as the trigger threshold.

Example: Video level is set at -40dBm . The trace freezes when the trigger condition is not met.

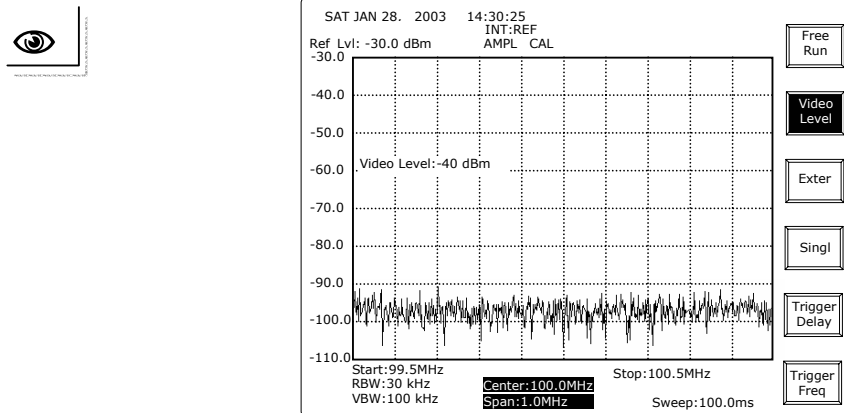

When the input signal level is over -40dBm , the sweep starts and captures the signal.

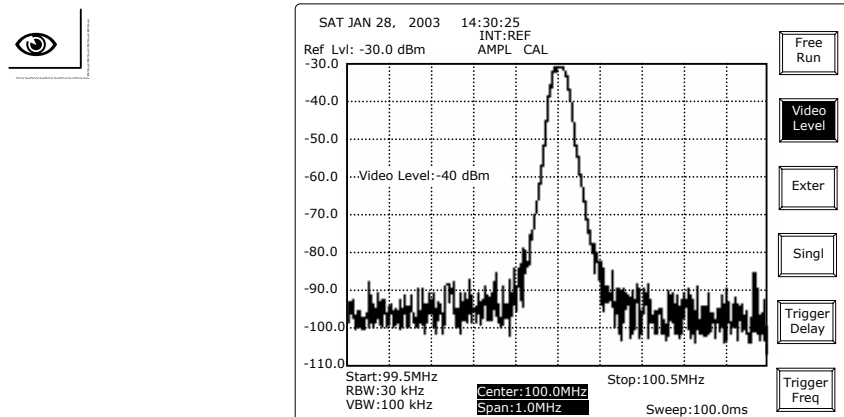

External Trigger

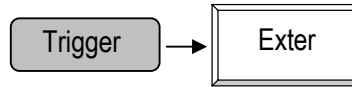

A 0 to 5V rising edge appearance in the External Trigger Input on rear panel will start the sweep in external trigger mode.

Single Trigger

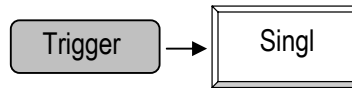

In Single trigger mode, it will sweep once when the trigger condition is met.

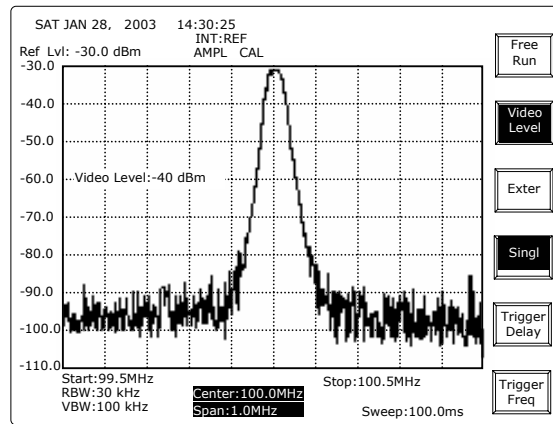

To quit Single mode by pushing the **Video Level** or **Exter** key again.

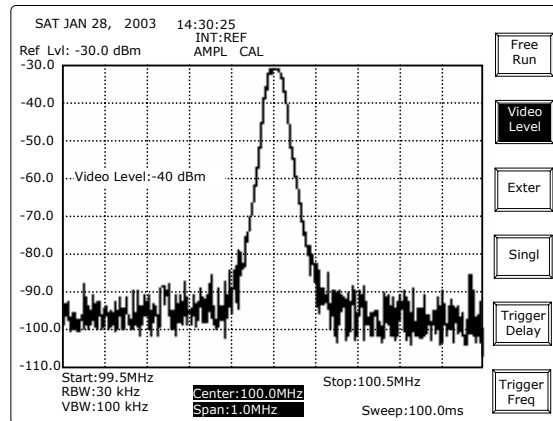
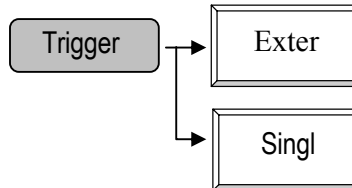

Trigger Delay

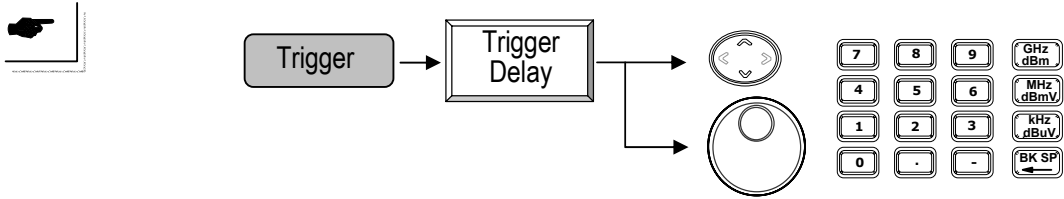

UP/DOWN and **Scroll**: To change the trigger delay by $1\mu s$ for every movement.

Editing: To enter trigger delay directly.

Trigger Frequency

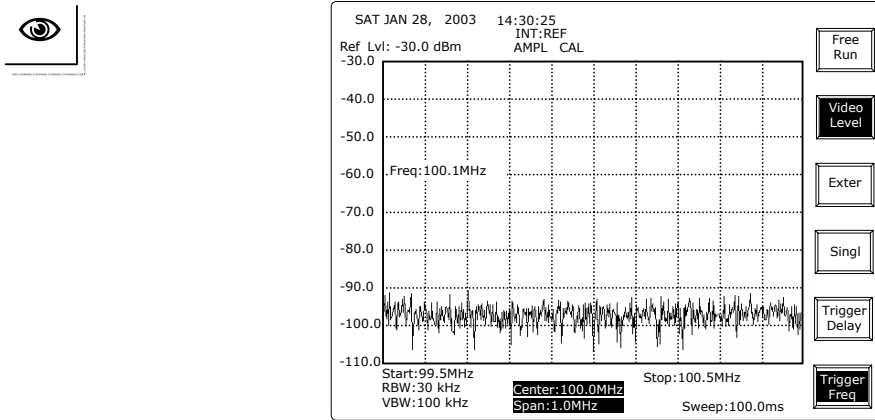
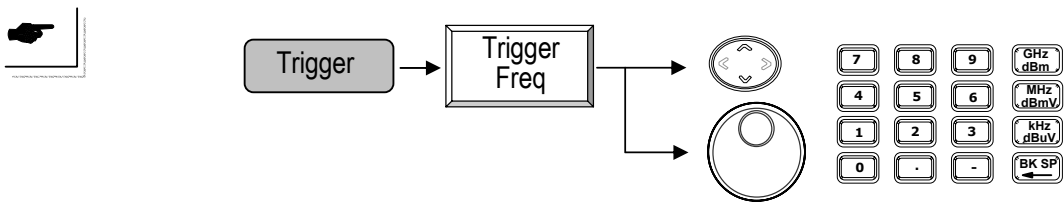

When a 100.1MHz signal rather than 100.0MHz appears at the input, trigger happens.

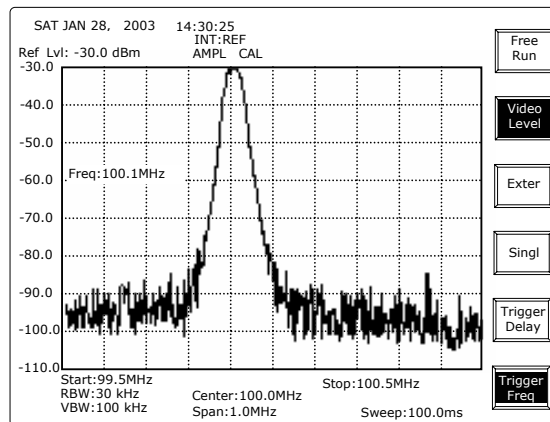

8.3.3 Display Functions

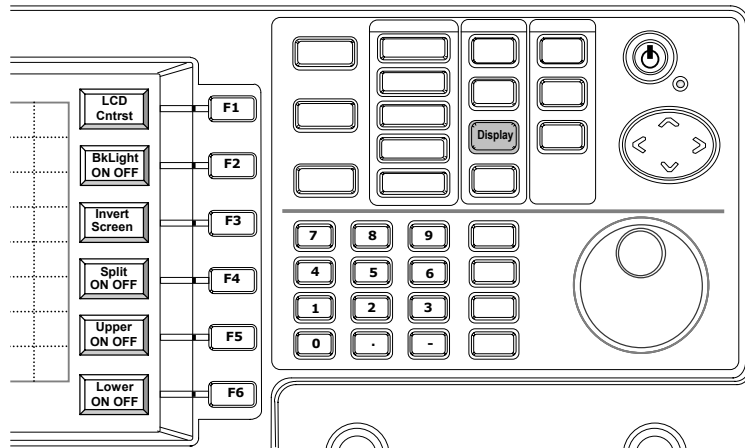

LCD Contrast, Back light and Inverting Screen are controlled with display functions. Two Split Windows offer separate measurement setting that is convenient to measure two signals at the same time.

LCD contrast

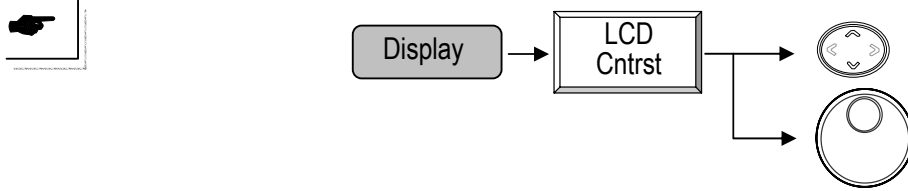

UP/DOWN and **Scroll**: To increase or decrease the contrast to fit the best visual effect.

Back Light



Repeating **BkLight ON/ OFF** key can switch the LCD backlight ON and OFF.

Invert Screen

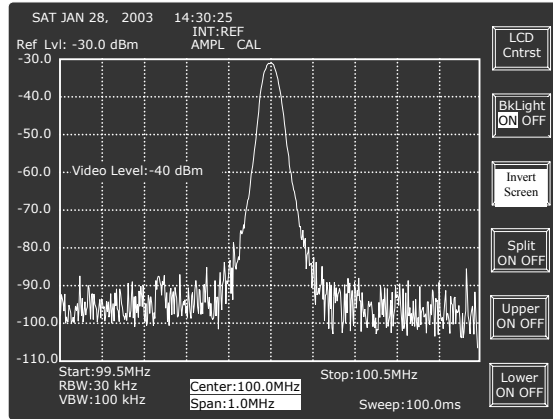
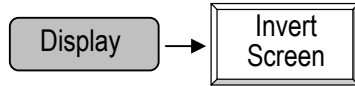

Split Window

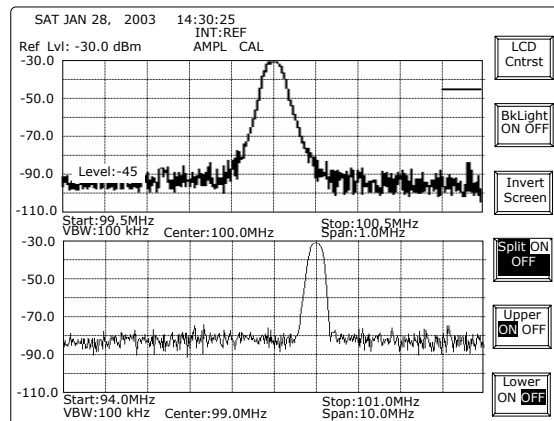
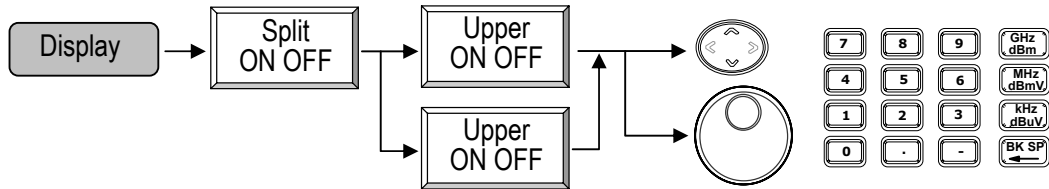

Display can be split into two windows and can be turned on and set separately. When both windows are ON, they will toggle the measurement and present the trace at the same time.

8.3.4 Save/Recall

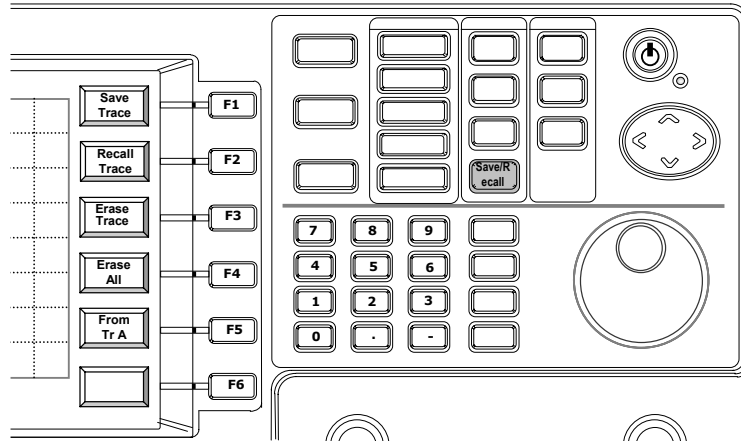

There are 100 memories for saving and recalling the measured trace. When saving the trace, the setup is also saved together. When the trace is recalled, the system will check if the setup of recalled trace is same as current setup. If they are different, there will be prompted message on the display to ask the user if the setup need to be changed.

Save trace

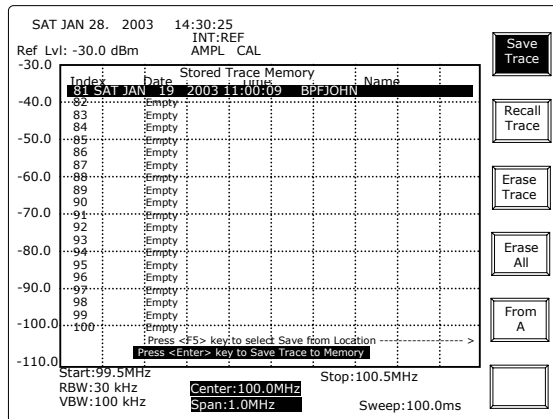
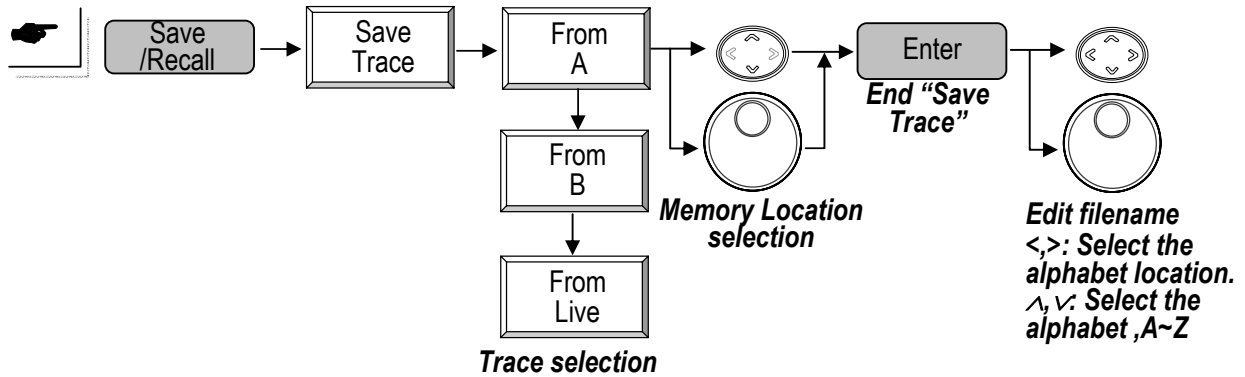

Recall trace

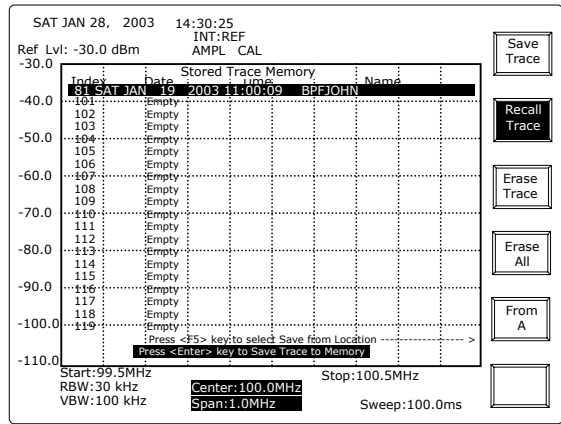
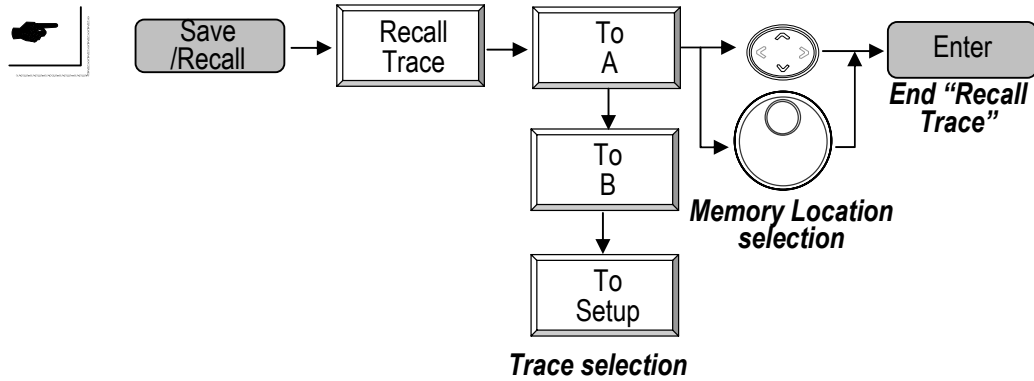

Erase Trace



Erase All

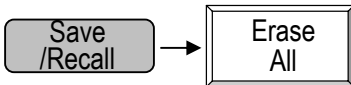

8.4 State Functions

8.4.1 Calibration

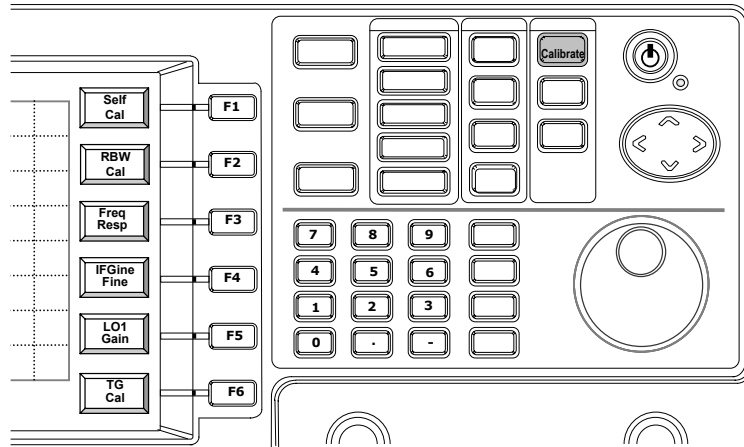

The Calibration function features the final calibration of manufacturing or tuning from the front panel. ***It is intentionally not allowed user to access. Refer to service manual for service demand.***

8.4.2 System

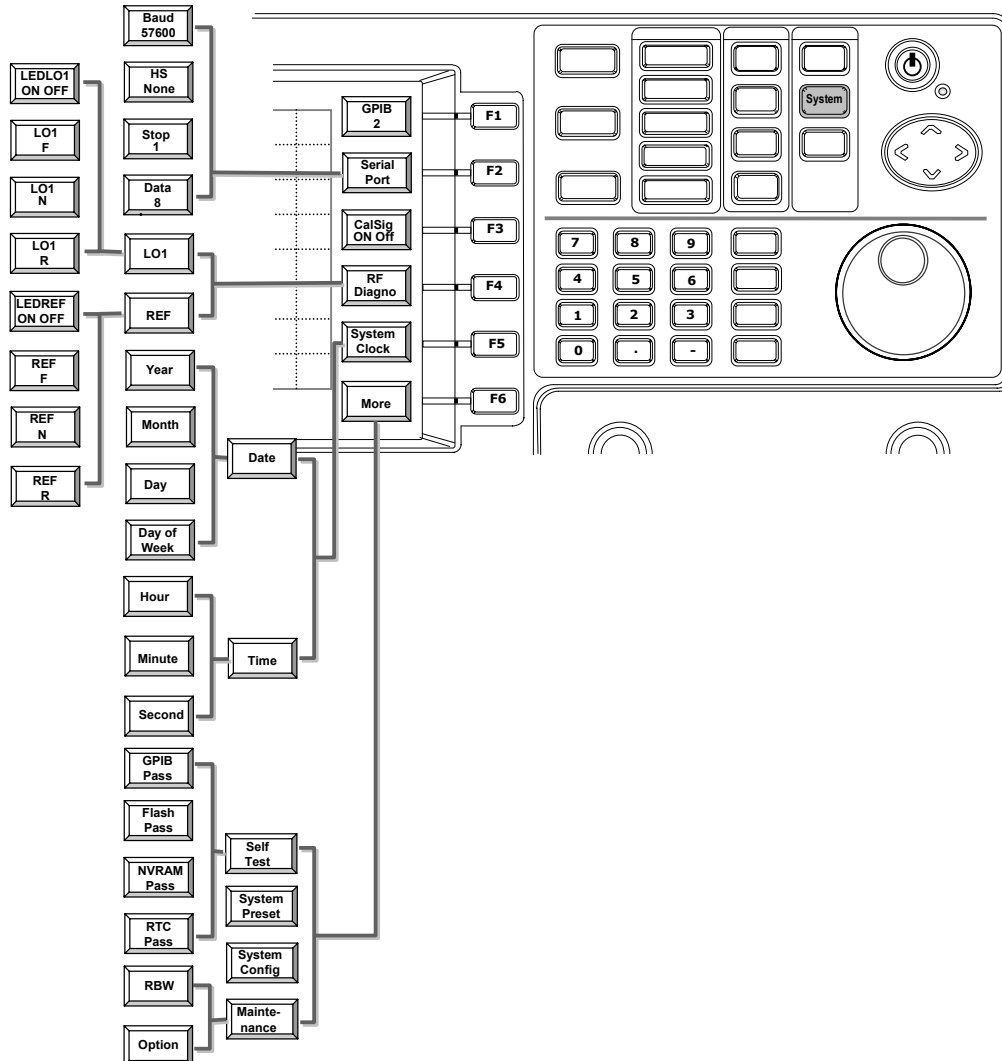

System functions include interface, calibration signal, simple diagnosis information, clock and calendar set and information of system configuration.

GPIB is to define the address from 1 to 30. **Serial Port** is to tell the configuration of RS232. GPIB is an option and RS232 is standard interface. **Calsig** function is to turn on the internal calibration signal which is a -30 dBm, 100MHz clock signal. **RF Diagno** function offers the information of **LO1** and **REF**erence signal. With the information, the basic diagnosis is easy to investigate. **System Clock** is used to set the calendar and clock.

Self Test provides the self test of digital system. **Preset** will reset the unit and go back to the default parameters. **System Config** will tell the system information like version number, serial number, ..., and so on.

Maintenance is to set the option configuration for manufacturer. *It is intentionally not allowed user to access. Refer to service manual for service demand.*

GPIB

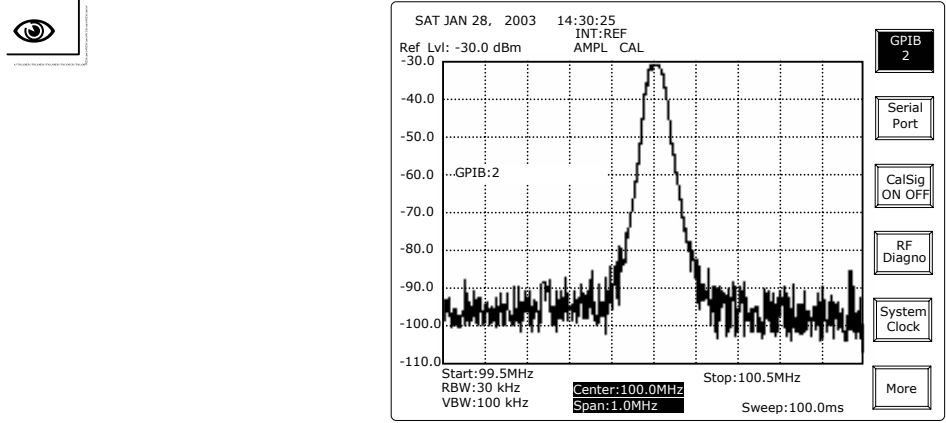
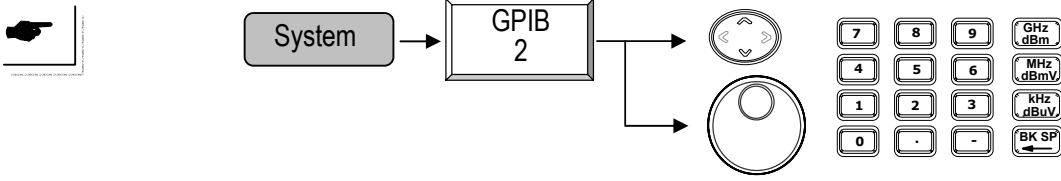

UP/ DOWN and Scroll: To increase or decrease the GPIB address of this unit.
Editing: Enter the number and end up with Enter key to specify the GPIB address.

Serial Port

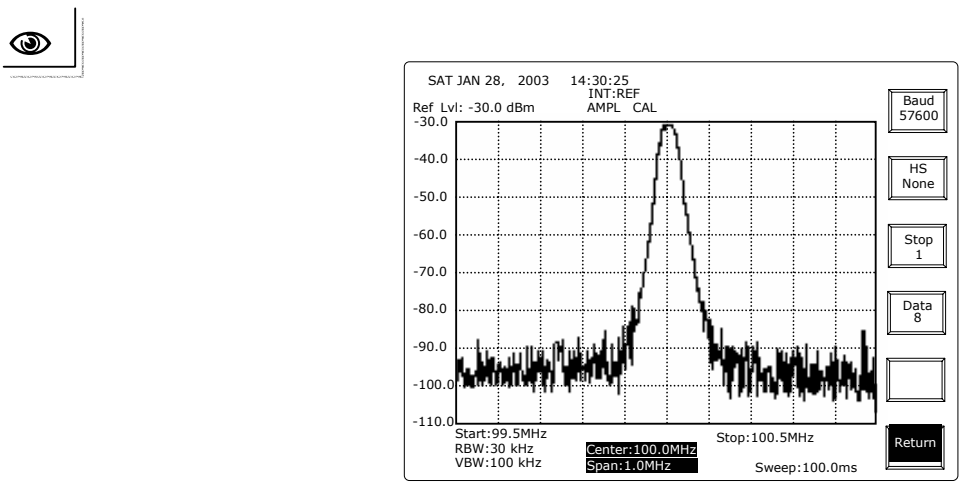

Serial Port will tell RS232 parameters.

RF Diagnosis

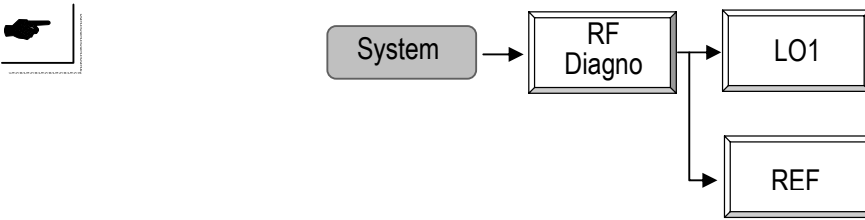

The **RF Diagno** will tell the **LED** status of LO1 and reference signal, **F Word**, **N Word** and **F Word**. The LED has to be set ON in normal operation.

System Clock

Date

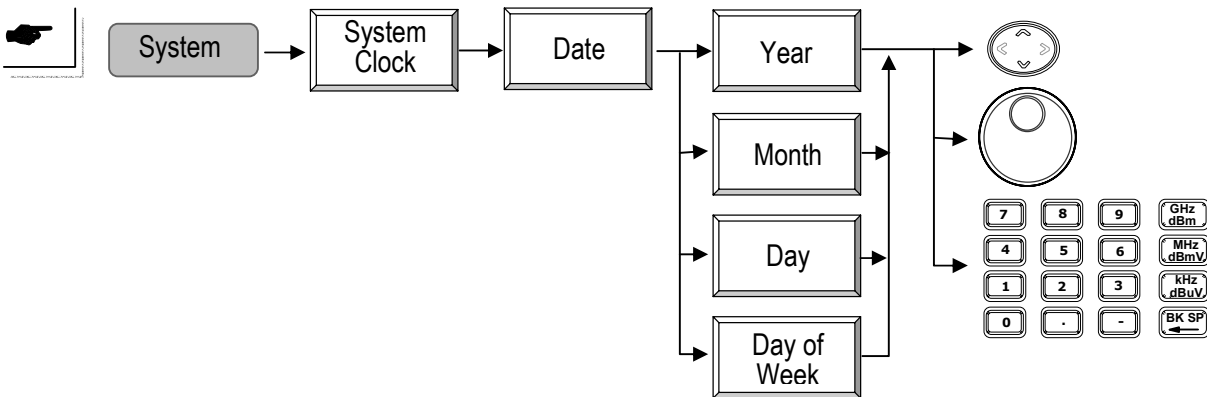

First select **Year**, **Month**, **Day**, **Day of Week** and followed with **UP/DOWN**, **Scroll** or **Editing** keys to specify the current date.

Time

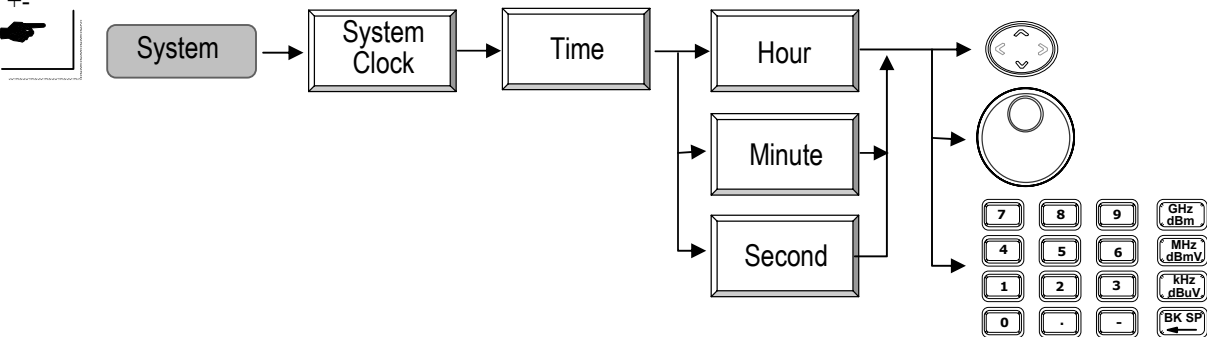

First select **Hour**, **Minute**, **Second** and followed with **UP/DOWN**, **Scroll** or **Editing** keys to specify the current date. The Hour here is in 24 hours form.

Self Test

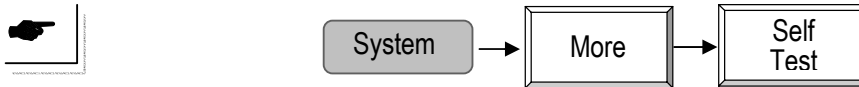

Self Test will tell the test results of **GPIB**, **Flash** memory, **NVRAM** and **RTC** (Real Time Clock).

System Preset

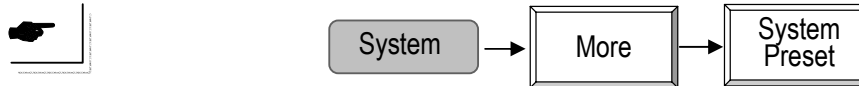

Preset will reset the unit and go back to the default parameters rather than the last one.

System Configuration

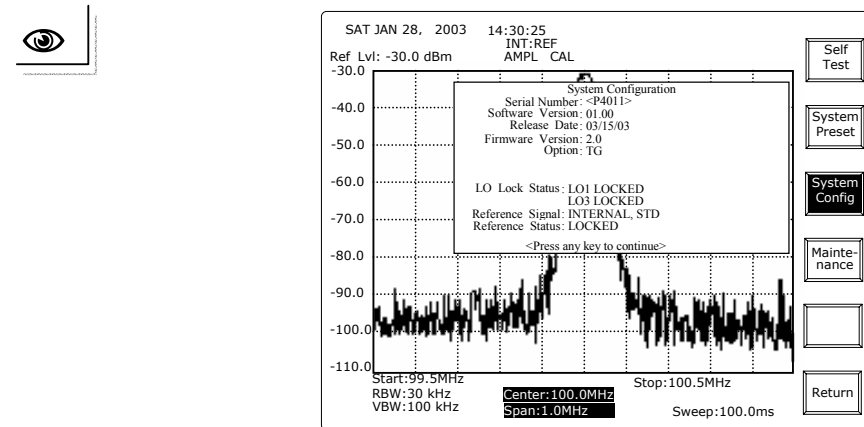
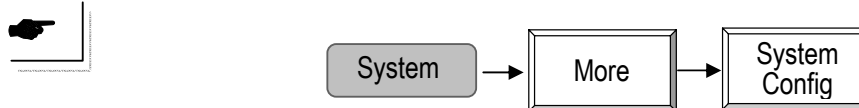

Maintenance

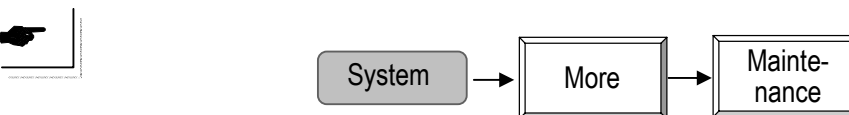

Maintenance is to set the option configuration for manufacturer. *It is intentionally not allowed user to access. Refer to service manual for service demand.*

8.4.3 Option

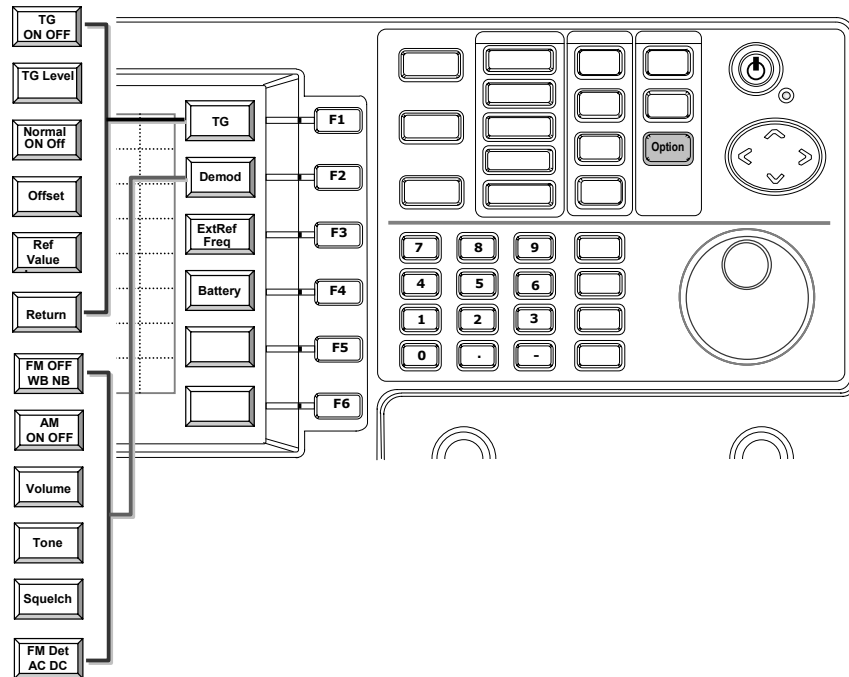

Option function is to control the function of TG, Demodulator, Extern Reference Frequency and Battery.

TG, Tracking Generator can be switched **ON/OFF** and its **Output Level** is controlled by TG function keys. **Offset** offers a frequency offset between TG output and input frequency of spectrum analyzer. It is programmable from -990kHz to 990kHz. When the offset is at 100kHz, it means the TG output frequency is 100kHz greater than spectrum analyzer.

Considering the flatness calibration of TG measurement, the **Normalization** is to make the through response flat. Therefore if the frequency response test is about to performe, directly connect the TG output and RF input with the same testing fixture to normalize first, then connect the DUT into test. The normalization will calibrate the uneven characteristics of fixtures used. The **Ref Value** allows that the normalized line of through response can be specified at any level.

There are AM and FM in the **Demodulator** option. The related control like **Tone** and **Squelch** are also provided. The **External Reference Frequency** allows 13 selections that depend on user's application. The most common frequency 10MHz is surely included. When the **Battery** Pack is installed, activating the **Battery** monitor will give the information of battery status.

Tracking Generator

Operation steps.

- (1) Setup the spectrum analyzer. Frequency range, Reference level, ..., and so on.
- (2) Set the TG level.
- (3) Connect the TG output and RF input with the fixture and cables.
- (4) Turn the TG output ON

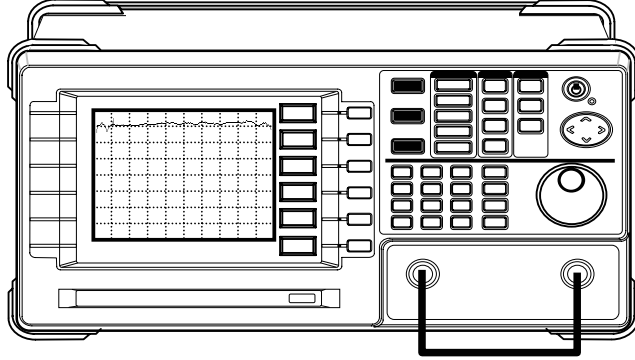

- (5) Perform Normalization function by turning the Normal ON.
- (6) Set the offset value.

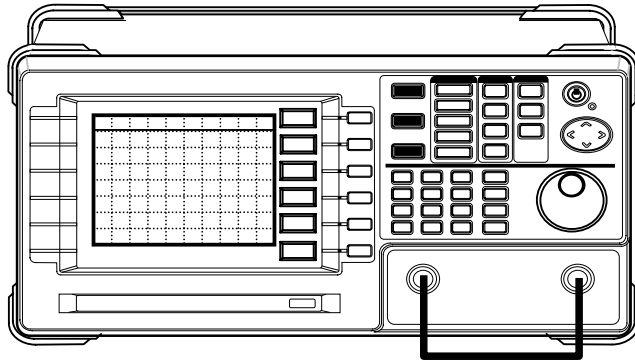

- (7) Plug the DUT into the connection. The frequency response is measured accurately.

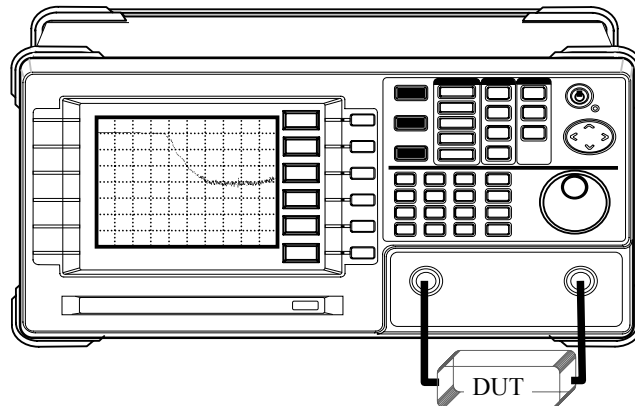

The operation detail is described in following paragraphs.

TG ON/OFF

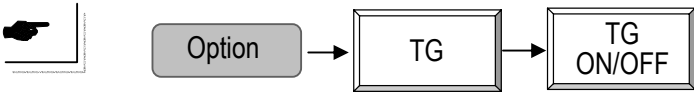

Pushing **TG ON/OFF** can switch TG ON and OFF.

TG Level

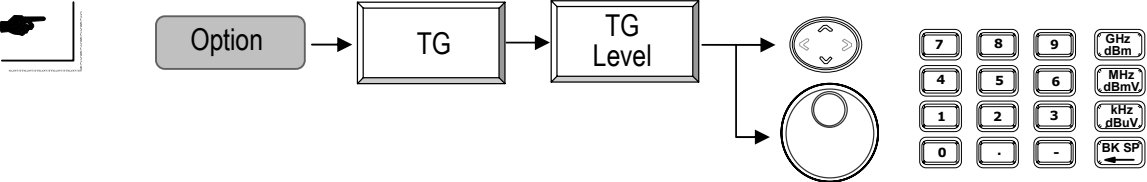

UP/DOWN and **Scroll**: To change the TG level from -50dBm to 0dBm at 0.1dBm resolution.
Editing: To specify the TG output level directly.

Normalize

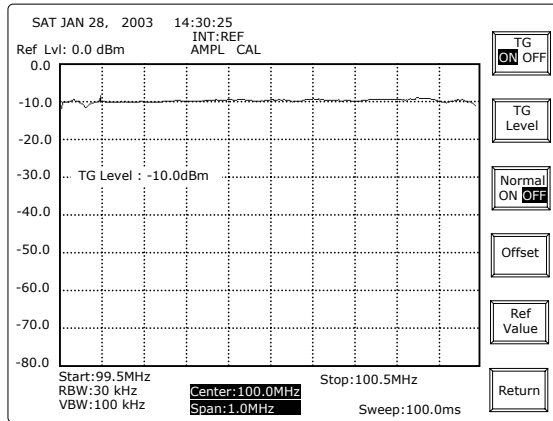
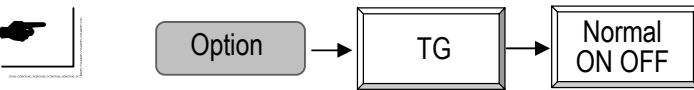

↓ Normalize

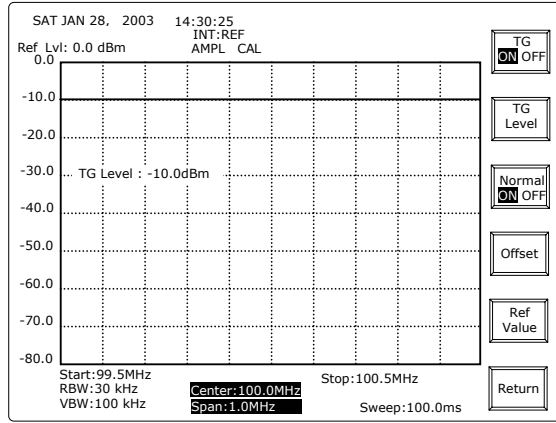

Offset

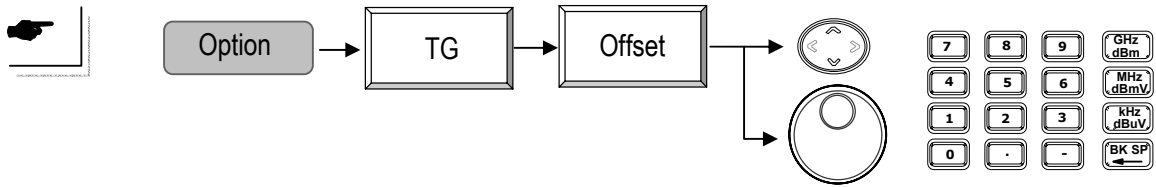

UP/DOWN and **Scroll**: To change TG offset frequency from -990kHz to 990kHz at 1kHz step.
Editing: To specify TG offset frequency from -990kHz to 990kHz directly.

Reference Value

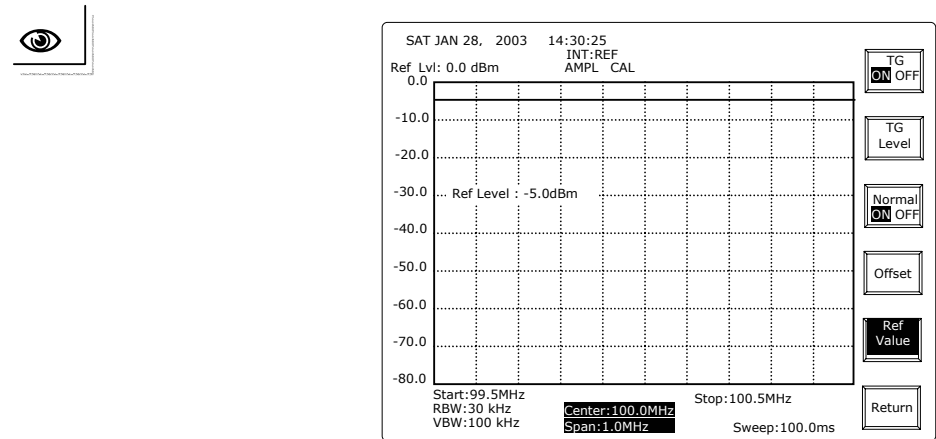
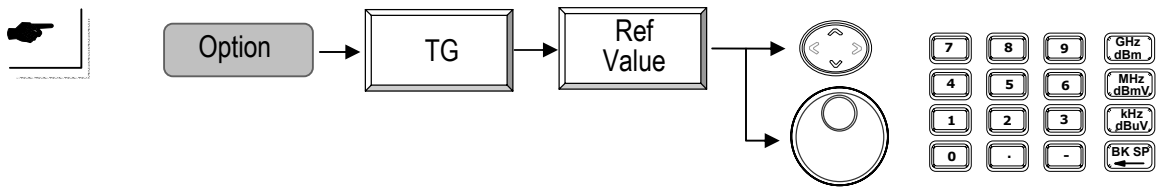

UP/DOWN and **Scroll**: To change the reference value in the display level range at 0.1dBm step.
Editing: To specify the reference value in the display level range directly.

Demodulation, FM

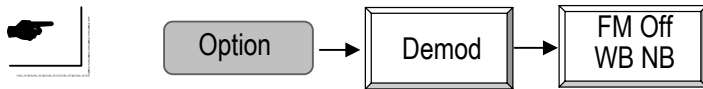

Push **FM ON WB NB** can switch the FM between Narrow Band FM, Wide band FM demodulation and OFF state.

Demodulation, AM

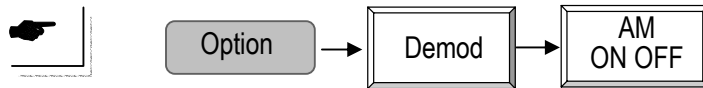

Push **AM ON OFF** can switch the AM ON or OFF.

Volume, Tone and Squelch Control

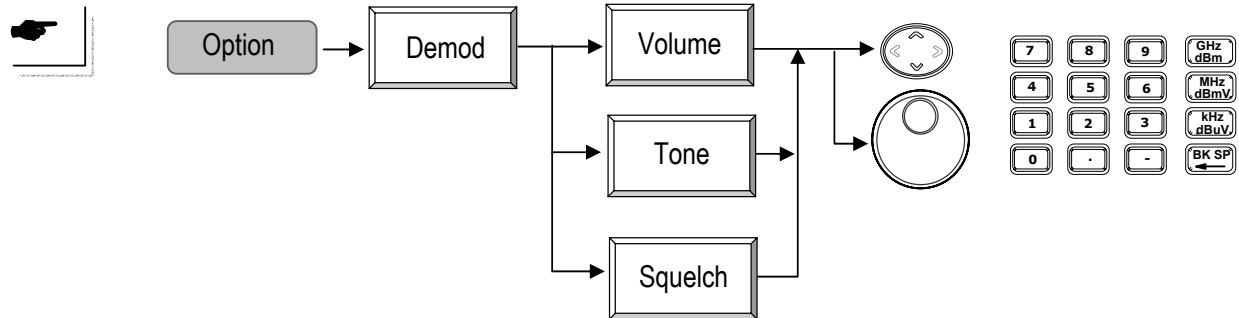

The volume, tone and squelch can be set from 0 to 64.

DC/AC FM Detection

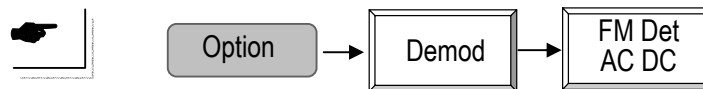

Pushing **FM Det AC DC** can select AC or DC detection of FM demodulation.

External Reference Frequency

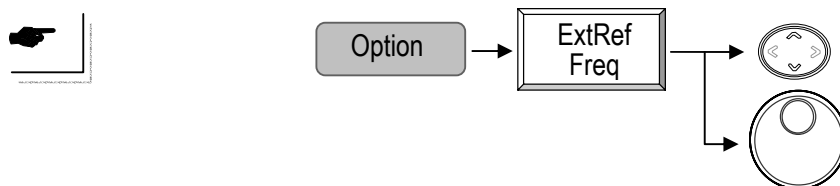

UP/DOWN and **Scroll**: To select the external reference frequency in use.

Battery

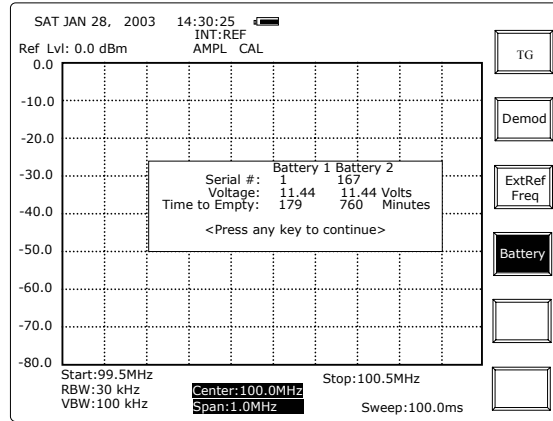
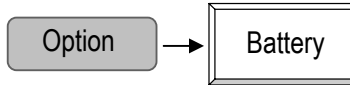

A battery sign will show up on the display if the battery pack is installed correctly. The Battery information is presented.

8.4 Power Control

Pushing and holding the power control switch for 2~3 seconds can set the unit to ON and Standby mode.

8.5 Diagnosis Information on the Display

The diagnosis information is listed below. Only one item of error message will be displayed. If several problems are detected, the first error message will be displayed. When all problems are solved, the **REF** status will appear. (One of **INT REF**, **EXT:REF** and **INT:MED**)

LO1 Unlock: First LO signal is not locked.

LO3 Unlock: Third LO signal is not locked.

INT REF: The reference signal is internal

INT REF Unlock: The internal reference signal is not locked.

EXT REF: The External reference signal is applying to be reference signal of system.

EXT REF Unlock: The system reference signal based on external reference is not locked.(*)

INT MED: The 1ppm stability reference is the system reference signal.

INT MED Unlock: The system reference signal based on 1ppm stability is not locked.

Battery Low: Battery pack is going to run out of energy.

NOTE(*): When External Reference is unlocked, make sure again the external reference frequency select the right frequency. Refer to Chapter 8.4.3 Option-External Reference Frequency.

Diagnosis information field

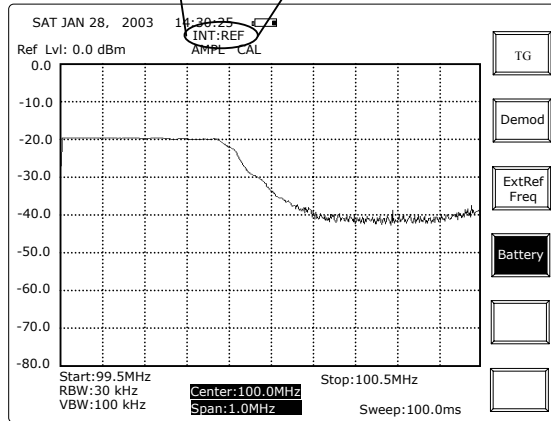
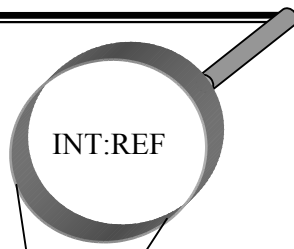

9.0 Specification

| | Item | Specification |
|--------------------------------|---|---|
| Frequency | Range | 9kHz-2.7GHz |
| | Accuracy | see time base |
| | Span Accuracy | see time base |
| | Span Range | 2kHz to 2.5GHz in 1/2/5 sequence, full span, zero span |
| | Phase Noise | -85dBc/Hz typical @ 1GHz 20kHz Offset |
| | Time Base | ± 10ppm, 0-50C, 5ppm/yr |
| Bandwidth | RBW Selections | 3kHz, 30kHz, 300kHz, 4MHz, |
| | RBW Accuracy | 15% |
| | Video Bandwidth | 10Hz to 1MHz in 1-3 steps |
| | Sweep time | 100 ms to 25.6 s |
| Amplitude | Input Range | -100dBm to +20dBm 1M to 2.5GHz, @3k RBW -95dBm to +20dBm 150kHz to 1MHz, 2.5GHz to 2.7GHz, @3k RBW -80dBm to +20dBm 50k to 150kHz, @3k RBW |
| | Reference Level Range | -30 to +20dBm, overload protected |
| | Accuracy | ± 1.5dB @100MHz |
| | Frequency Flatness | ±1.5dB, |
| | Display Range Linearity | ± 1.5dB over 70dB |
| | Overload protection | +30dBm, ±25VDC |
| | Average Noise Floor | -130dBm/Hz 1MHz to 2.5GHz -125dBm/Hz 150kHz to 1MHz, 2.5GHz to 2.7GHz -105dBm/Hz 50k to 150kHz |
| | Harmonic Distortion | <-60dBc @-40dBm Input |
| | Non-harmonic Spurious | <-60dB, down from Ref. Level 150k to 2.7GHz <-50dB, down from Ref. Level 9k to 150kHz |
| | Third Intermodulation | <-70dBc @-40dBm Input |
| | Trace Detection: | Average, Maximum Hold, Freeze, Trace Math |
| Input | RF input | |
| | Overload Protection | +30dBm Continuous |
| | Impedance: | 50 Ohm nominal |
| | Return loss | <1.5:1 @150k to 2.5GHz, 0dBm Ref. Level |
| | Connector | Type N Female |
| External reference clock input | 64k, 1M, 1.544M, 2.048M, 5M, 10M, 10.24M, 13M, 15.36M, 15.4M, 19.2M | |
| Others | Internal Memory | 100 traces or Setup |
| | Power measurement | ACPR, OCBW, Channel power |
| | Reference clock output | 10MHz |
| General | Display: | 640 x 480 high resolution graphical LCD, B&W |
| | Interface: | RS232C, |
| | Weight: | 4.5kg without options |
| | Size | 330 (W) x 170(H) x 340(D) mm |

Options

| | | |
|----------------------------|--|--|
| Tracking Generator* | Frequency Range | 9kHz to 2.7GHz |
| | Amplitude Range | -50dBm to 0 dBm |
| | Amplitude accuracy | ±1dB @100MHz, 0dBm |
| | Amplitude flatness | ±1.5dB @0dBm |
| | Harmonics | <-30dBc |
| | Reverse Power | +30dBm |
| | Impedance | 50 Ohm nominal |
| | Return Loss | <1.5:1 |
| Demodulation | Am, FM | AM, FM |
| EMI Filter* | EMI filter and detector | 9kHz and 120kHz 6dB RBW Quasi-Peak Detector |
| Interface* | GPIB | IEEE-488 SCPI Command Compatibility |
| DC/AC Power Supply* | DC/AC dual mode power supply | DC-12V and AC 100 to 260V |
| Battery Pack* | Chargeable from AC Line, Li Ion battery pack. ⁽¹⁾ | |

Note (1): Battery Pack works and be charged with AC line only when the DC/AC dual mode power supply is installed.

